



Schweizerische Eidgenossenschaft
Confédération suisse
Confederazione Svizzera
Confederaziun svizra

Département fédéral de l'environnement,
des transports, de l'énergie et de la communication DETEC
Office fédéral de l'énergie OFEN

PERFORMANCE GLOBALE EN ÉCLAIRAGE

GLOBAL LIGHTING PERFORMANCE

Executive summary, January 2015

Based on the final report: version 07.29.2014

Estia

Estia SA: Bernard PAULE, Julien BOUTILLIER, Samuel PANTET

www.estia.ch

Translation and Executive Summary made possible with the active support of



www.es-so.com

Abstract

This project focused on the effective use of movable shading devices in offices, and on the impact on the indoor day lighting.

The first part of the project consisted in the observation of the actual use of sunscreens when the command is not automated (administrative buildings, operating webcams from 01-02-2013 to 31-01-2014 over 125 openings, e.g. more than 500,000 individual blind positions analysed).

The key finding is that sunscreens are adjusted infrequently (less than 2 movements blinds / week) regardless of the orientation or season. The consequence of this misuse is that the contribution of natural light is far from being optimised.

The second part of the project focused on the simulation of the actual contribution of daylight in each of the observed rooms (Simulations DIAL + / Radiance).

This allowed us to compare the results with those that would have been achieved with automated blinds.

The results of these simulations were then used to estimate the electricity consumption for lighting. This study shows that the energy savings associated with automated blinds can reach several kWh/m² per room and per year.

Comparison with SIA 380/4 calculations shows that the actual version of the Swiss Standard underestimates the potential related to blinds automation and also tends to overestimate the effects of artificial lighting automated control.

The main conclusion of this study is that the implementation of automatic blinds can significantly increase the number of hours artificial lighting is not required while preserving the visual comfort and freedom of choice for users.

The other conclusion is that the Swiss Standard should encourage the use of daylight by imposing specific targets on this topic.

1. Context / Objectives

Solar shading constitutes a major element in the energy performance of a building, both for the thermal balance and for lighting. The users are not always aware of this and will move the shading for all kinds of reasons, except energy saving. This study will quantify how users handle manually operated shading devices and will show how this behaviour will affect electricity use for lighting when compared to automated operation of the shading devices.

This study is an observation of the solar shading devices (external venetian blinds) of four (4) office buildings in the EPFL Innovation Park area in Ecublens, near Lausanne, Switzerland. The objective is to characterise the use of the blinds when these are not automated and its consequences on the level of natural light in the buildings. The purpose is also to make recommendations for a review of Swiss Standard 380/4 regarding lighting.

The blinds were tracked over a period of one year and are situated on four levels, from the second to the fifth floor, as indicated by the yellow dotted lines on one of the buildings in fig.1.



Figure 1: Photo of the west façade of building PSE-C on February 5, 2013, overcast sky

This picture already shows that there is no correlation between the position of the blinds (down or up) and the weather conditions. This building has 58 groups of blinds, only 11 windows show blinds in the ‘up’ position, while the sky is overcast and there is no risk of glare. The blinds are completely down on 7 windows, preventing the harvesting of natural light. Behind 15 windows, the electric lights are on while the blinds are partially or completely down, in the middle of the afternoon of a day in May. In other offices, the lights are not switched on even when the blinds are down.

2. Procedure & methodology

2.1 The buildings

The four buildings are occupied by start-ups of the EPFL (Swiss Federal Institute for Technology, Lausanne). Each building is observed with a webcam, figure 2 indicates their position, one per orientation:

- Building PSE-B, south-oriented façade, 40 groups of external venetian blinds, all manually operated by crank, tracked from building PSE-C.
- Building PSE-D, east-oriented façade, 27 groups of external venetian blinds, motorised but not automated, with switches placed close to the windows. Observed from PSE-C.
- Building PSE-C, west-oriented façade, 58 groups of external venetian blinds, all manually operated by crank, tracked from PSE-D.
- Building QIE, north-oriented façade, observed from PSE-C like the other façades. Given the low number of blind movements and the low solar intensity, these data have not been taken into account.

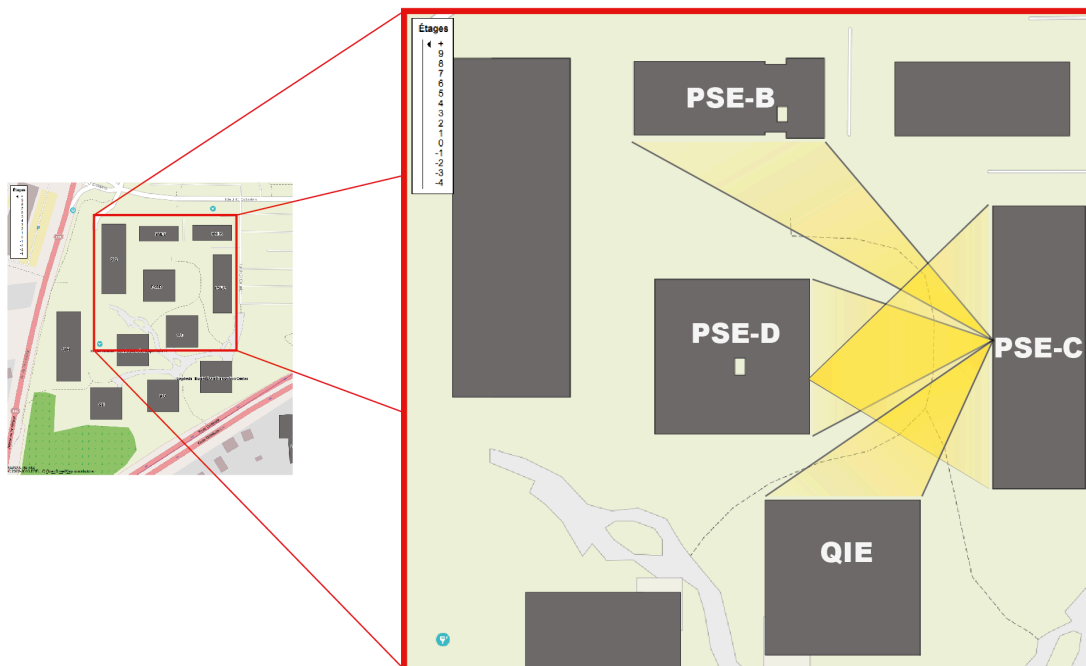

Figure 2: position and direction of webcams

2.2 Instruments

The position of the blinds is recorded and saved every hour by four webcams, full HD Model D-Link DCS2210. The images are subjected to visual analysis to determine at each time the position of the blinds.

2.3 Observations

Every hour, the covered area of the windows is recorded, in steps of 25% as shown in Figure 4. The tilting angle of the blinds' slats is classified in three (3) categories. The testing period ran from February 1, 2013 till January 31, 2014.

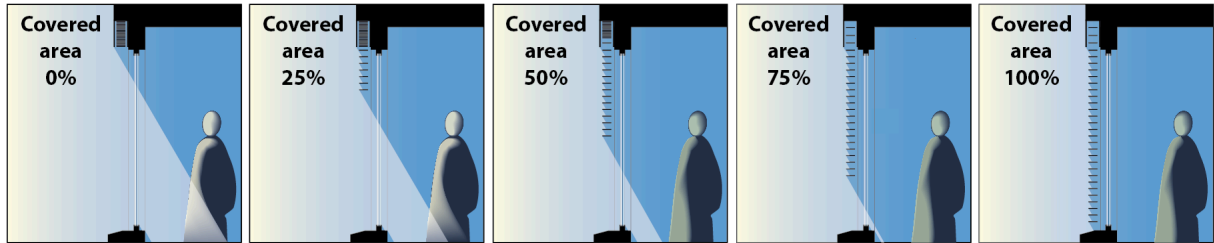

Figure 3: The covered area of the window was recorded and classified in 25% steps.

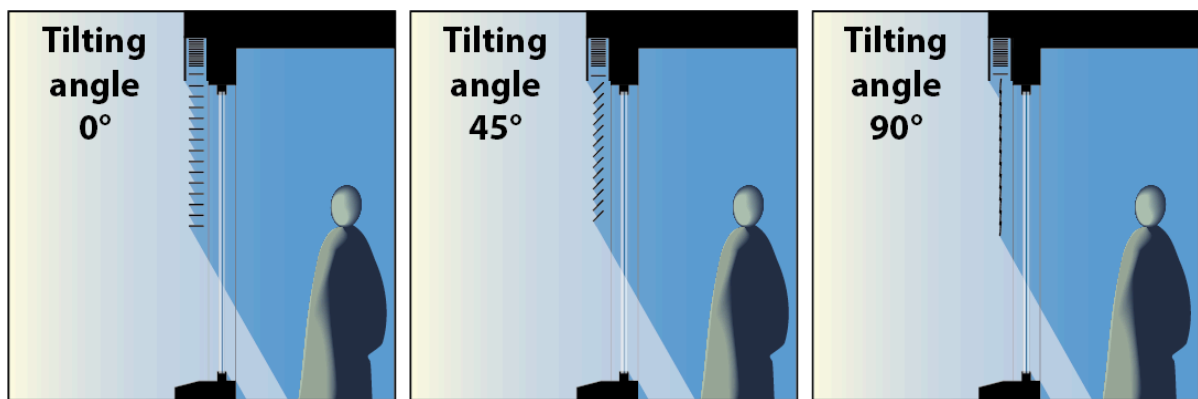

Figure 4: The tilting angle of the slats was recorded every hour and classified into three categories : 0°, 45° & 90°.

3. Results and findings about blinds movements

3.1 Movements recorded

A blind going ‘up’ or ‘down’ is recorded as a ‘movement’. A change of slat angle in a given blind position also represents a ‘movement’. However, when the slat angle is changed during an ‘up’ or ‘down’ action, this is not considered a separate ‘movement’.

The table below shows the total number of movements during the 365-day period of observation. The grey areas indicate the number of movements per window (total number of movements divided by the number of windows per façade). As the recording took place every hour, it is possible that some movements may not have been detected. However, it is highly improbable that a user will change the position of a blind twice in one hour, with the blind in exactly the same position the second time. We may therefore consider that the results are relevant.

| | East façade | | South façade | | West façade | |
|----------------------------------|-------------|-------------|--------------|-------------|-------------|--------------|
| Number of blinds observed | 27 | | 40 | | 58 | |
| Movements ‘up’ | 990 | 36.7 | 1115 | 27.9 | 1189 | 20.5 |
| Movements ‘down’ | 1062 | 39.3 | 1226 | 30.7 | 1421 | 24.5 |
| Slat angle change | 365 | 13.5 | 697 | 17.4 | 3505 | 60.4 |
| Total number of movements | 2417 | 89.5 | 3038 | 76.0 | 6115 | 105.4 |
| Number of movements per week | 48.5 | 1.72 | 58.4 | 1.46 | 117.6 | 2.03 |
| Weighted average per week | 1.74 | | | | | |

Table 1: summary of blind movements during office hours on three façades – grey areas indicate movements per window.

Table 2 displays the frequency of the blind movements: the results show the same tendency for all façades, with the south façade conspicuously low: more than half the occupants use the blinds less than once a week!

With only 12% of the occupants who use their blinds once per day (> 4 movements per week) one can only conclude that the occupants are poor managers of their solar control systems.

| Façade | Frequency of blind movements per week | | | | |
|----------------|---------------------------------------|-----------------|-------------------|------------------|------------------|
| | ≤ one movement | ≤ two movements | ≤ three movements | ≤ four movements | ≥ four movements |
| East | 37% | 33% | 15% | 4% | 11% |
| South | 53% | 23% | 12% | 5% | 7% |
| West | 36% | 26% | 19% | 3% | 16% |
| Average | 41% | 26% | 16% | 4% | 12% |

Table 2: average movement frequency per façade, including slat angle changes.

South orientation, manually operated blinds

As table 1 shows, a total of 3038 movements were recorded over the one-year period for the 40 groups of blinds, including changes of slat angle in a given blind position. That means, on average, **1.46 movements per week and per blind**, which is extremely low. Distributed on a per-month basis, we find a low of 3.8 movements per month in May and a high of 9.3 in November.

East orientation, motorised blinds

A total of 2417 movements were recorded for 27 groups of motorised blinds over the one-year period, including slat angle changes in a given position, which results in an average of **1.72 movements per week and per blind**, a very low figure again. The monthly distribution shows a low of

1.7 movements per month in December and a high of 14.7 in June. Here, the more intense use during the summer months of June, July and August is clearly visible.

West orientation, manually operated blinds

A total of 6115 movements were recorded for 58 manually operated groups of blinds over the one-year period, including slat angle changes in a given position, resulting in an average of **2.03 movements per week and per blind**, a number marginally higher than for the other façades. As table 1 shows, a large proportion of the movements were for slat angle changes. Again, the monthly averages vary from one month to another, with 3.2 in December and 14 in June.

3.1.1 Movements on a per-day basis

For the **south** façade (fig. 5), the records show that moving the blinds ‘up’ primarily happens before 11h and after 17h. Closing the blinds to the ‘down-position happens during the day, with a peak at 14h, after the lunch break.

The **east** façade (fig. 6), which is mainly exposed to the sun in the morning, logically shows a clear tendency to bring the motorised blinds down in the morning, while the ‘up’ movement in the afternoon is less frequent than one might expect, with slat angle changes spread all over the day.

The **west** orientation shows the blinds being raised in the morning, in line with the fact that this orientation is not exposed to the sun in the morning (figure 7). In the afternoon, the blinds are brought down, while there is a high frequency of slat angle change, with a peak in the morning between 8h and 9h, probably in an effort to improve the view to the outside.

Figure 5: SOUTH façade: Daily distribution of blind movement

Orange = down,
Light blue = up,
Dark blue = slat angle change

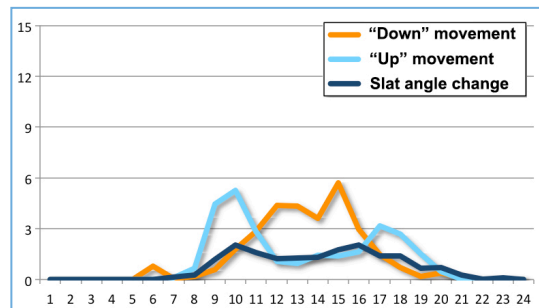

Figure 6: EAST façade: Daily distribution of blind movement

Orange = down,
Light blue = up,
Dark blue = slat angle change

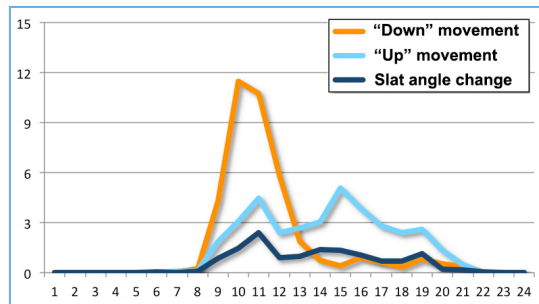
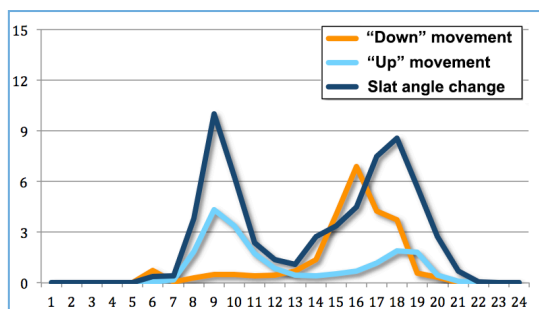

Figure 7: WEST façade: Daily distribution of blind movement

Orange = down,
Light blue = up,
Dark blue = slat angle change



3.1.2 Percentage of window covered

Apart from observing the ‘up’ and ‘down’ movements of the blinds, we have also looked at the degree of coverage of the glazed surface (fig. 8).













| Facade | Winter | Summer | Average |
|---------------------------|--|---|--|
| East (Motorised) | 22%  | 48%  | 35%  |
| South (Manual) | 69%  | 78%  | 74%  |
| West (Manual) | 58%  | 55%  | 56%  |
| Average (weigthed) | 53%  | 60%  | 57%  |

Figure 8: Percentage of window covered as a function of the façade orientation and the season.

Weighted

On the south façade, an average of 74% of the surface was covered by the blinds. On the west orientation, the number was 56%, while the east side had the lowest percentage (35%) resulting in a weighted average of 57% for all the façades together, leaving 43% of the glazed surface uncovered. To the extent that we know that the top of the windows is also the most effective to bring light to the back of the room, we can predict that the manual management of blinds leads to a very poor use of natural light.

3.1.3 Summary of findings

- The number of movements ‘up’ or ‘down’ is substantially higher on the **east** façade, most likely because these blinds are motorised and therefore easier to use
- The number of slat angle changes is four times higher on the **west** façade than on the other ones. When the sun is going down on the west side, the slats are moved to avoid direct radiation
- The lowest number of blind movements is on the **south** façade: during most of summer time, the blinds are down and the slats horizontal, blocking the sun all day long
- The total number of blind movements is extremely low: 1.74 times on average, per week and per window. The significant lack of use of the blinds means that energy is being wasted.
- The average percentage of the glazing which is obstructed by the blinds is very important

4. Contribution to natural daylight in the offices

To evaluate how much natural daylight is brought into the offices, we conducted simulations, hour by hour during the complete test year, of the level of natural daylight in each of the rooms, taking into account the blind position and the climatic conditions (from MétéoSuisse station in Pully). The simulations were made with an advanced release of the DIAL+Lighting software, based on the calculation engine RADIANCE, and targeted 5 points at 0.75m from the floor. To keep the simulation time within limits, the geometry of the slats has been simplified (flat slats with a reflectance factor of 0.30). The results may therefore be somewhat underestimated but the comparison between scenarios remains valid.

Where the level of light is at least 500 Lux it will be indicated as Auto₅₀₀, with Auto₁₅₀ meaning that the level is at least 150 Lux.

4.1 South façade

Figure 9 shows the natural light distribution in the 40 offices of this façade and at the five points mentioned above, with point 1 being the closest to the window and point 5 the most remote (detailed curves of east and west façades are available in the full report).

Naturally, the locations closer to the window will show the highest percentage of light penetration.

- The highest Auto₅₀₀ result of 82%, logically, was recorded on point 1 in Window 5, with 16% in point 5, but this is a window where the blinds were almost always ‘up’ (no movement).
- At the other end of the range of results, Window 10 shows the lowest natural light contribution, with only 26% Auto₅₀₀ in point 1 and 0% in point 5. Logically again, as the blinds on this window were 91% closed on average (18 moves per year or 437 h between moves).

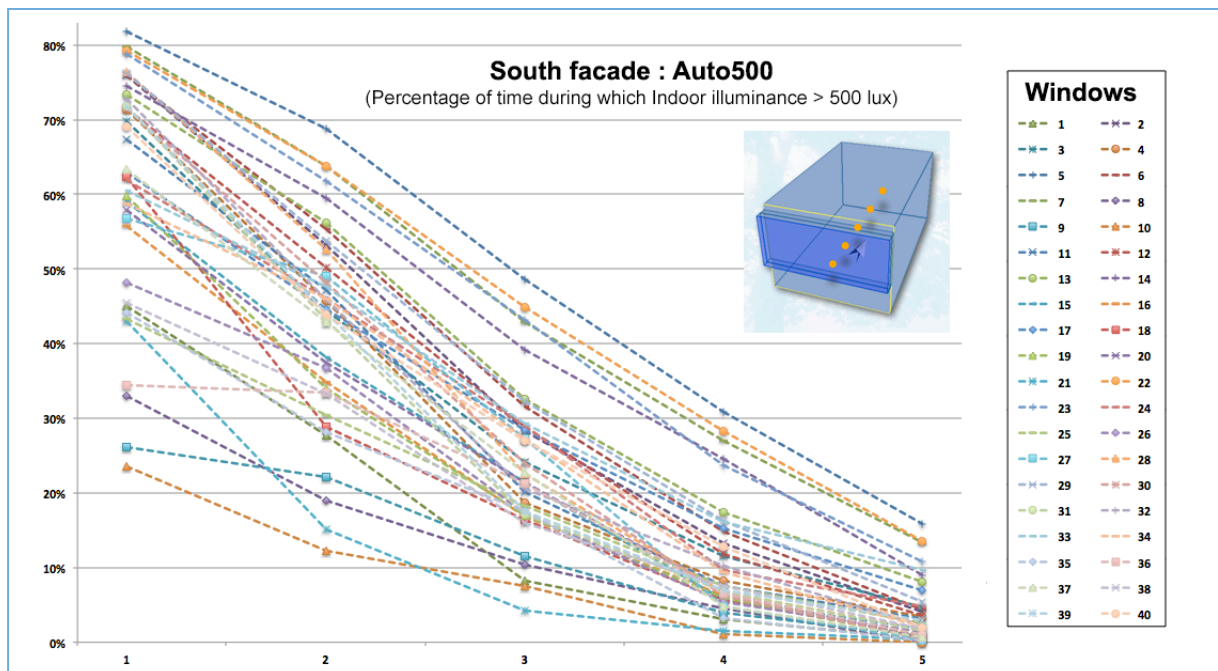

Figure 9: Percentage of the time (7 AM- 6 PM), during which daylight contribution ≥ 500 lux on the five reference points, for each of the 40 south oriented rooms. Each line corresponds to a room. Point 1 (left), is located close to the window and point 5 (right) is at the back of the room.

4.2 East façade

The spread of the results of this building is smaller than in the case of the south façade.

- Window n° 1 of the east building shows the highest numbers: in point 1, Auto500 = 79%, in point 5 it is 11%.
- The lowest score in this building is for room n° 23, with Auto500 = 40% in point 1 and Auto500 = 3% in point 5.

4.3 West façade

- Window West n° 37 shows Auto500 results between 81% and 7%. In this office, the blinds were always in the 'up' position and covered only 0.1% of the glazed surface.
- Office West n° 2 had the lowest numbers, even close to the window (between 3% and 0%), explained by the fact that the blinds were down most of the time (94.4% covered).

4.4 Summary of contribution to light levels

- For the same room, the way the blinds are used is unpredictable and therefore the effective gain in natural light varies considerably.
- The daylight autonomy figures (Auto₅₀₀) show ranges of 3 to 82% for point 1, close to the window, between 1% and 48% in the centre of the room (point 3) and between 0% and 16% in point 5, furthest from the window.
- In any one of the buildings, some users are very 'tolerant', often leaving the blinds in the 'up' position, others are more 'protective', closing the blinds most of the time
- The west façade shows great differences between users, whereas the east façade has the narrowest band of user practice. The motorised operation on the east façade seems to encourage a better use of the natural light potential.

4.5 Observing how the users handle artificial light

Over 100 sets of photos were taken showing at which Lux-level the electric lighting was switched on, taking into account the position of the blinds and the Radiance calculations.

It appears that half the users did not switch on the electric lights until Illuminance levels in the centre of the room were between 29 and 147 Lux, a much lower value than the norms for office work require: 500 Lux. The users do not seem to care much about the ambient light level, especially when they work on computer screens. Without an automatic system to switch on the lights, the real-life threshold for electric lighting (<150 Lux) is much lower than the legally required level in offices (500 Lux). One conclusion could be that, with an automatic system for switching on the electric lights reacting at a threshold level of 500 Lux; the number of hours with electric lighting will be substantially higher than in the case of a manual switch.

4.6 Scenarios for automating the blinds

The second part of the study deals with the comparison of the results if the blinds had been fully automated. It should be emphasised that the study **did not focus on the thermal aspects but only on the lighting issues**. With the DIAL+*Lighting* software, a second run of simulations was done, for every façade, hour by hour during one year, with each of the two automation systems described below: one based on continuous control, the other based on a reset principle.

4.6.1 Scenario 1: “Continuous”

In this scenario the blinds will be lowered each time the incident solar radiation reaches 200 W/m² during the hourly measurements. In summertime, the blinds will then be lowered 75%, in wintertime 100%. The slat angle will vary with the position of the sun, from 0° to 20° to 25° and 45°. When the sun is absent, the blinds are raised to benefit from diffuse lighting, but a buffer time of one hour is set so that the users are not interrupted by too many movements.

4.6.2 Scenario 2: “Reset”

In this case, specific blind movements are initiated in the absence of the users, in the morning before work and during lunch break. In § 3.1.2 it was noted that the percentage of coverage is very high. The user seems to lower the blind as soon as he suffers from glare by the sun, but he will not adjust this when the sun disappears. Instead, the electric light is possibly switched on. Since this study focuses on energy savings for lighting, we will command the blinds to open twice a day which will reduce the area of window coverage and let in more natural light.

Conditions for glare situations: The “Reset” scenario does not resolve the glare problem insofar as no automatic movement is done when the sun hits the façade. However, at each time step, we calculated the DGP index (Daylight Glare probability) for a typical user located at 1.15 m from the façade. As soon as DGP > 0.45 (which corresponds to a glare situation), we thus assume that the user lowers the blinds. The difference with the “continuous” scenario is that the blinds are not raised when the sun disappears, but only at the next “Reset” command (lunch break or next morning).

4.7 Venetian blinds: comparison of user values with the two scenarios

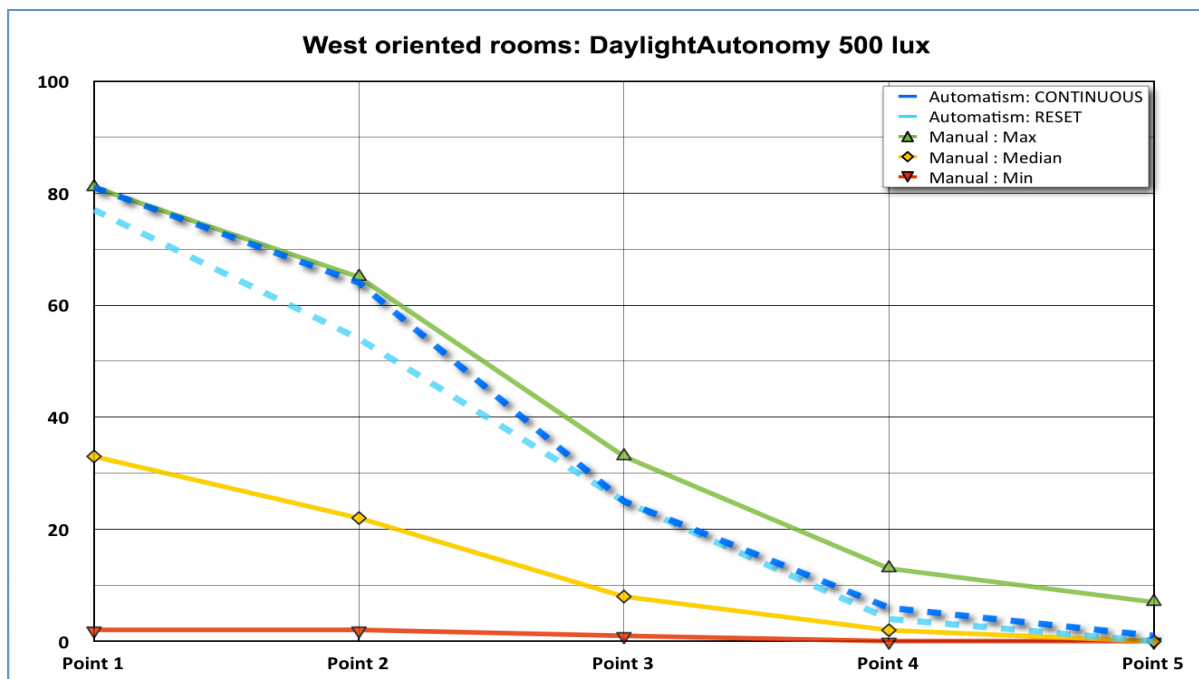

Figure 10: Daylight autonomy profiles for West oriented rooms (500 Lux required).

- Green line = Maximum observed (blinds almost always opened throughout the year).
- Orange line = Median values (50% of the users are above, 50% below).
- Red line = Minimum observed (blinds almost always closed throughout the year).
- Dark Blue dashed line = Day lighting autonomy achieved with “Continuous” automated blinds.
- Light Blue dashed line = Day lighting autonomy achieved with “Reset” automation.

4.7.1 An illumination level of 500 Lux

The daylight level of 500 Lux is then calculated and compared between, on the one hand, the 'manual' situation, where the users operate (or not) the blinds, and on the other hand the two scenarios (Continuous and Reset). For each orientation, the maximum, minimum and median 'manual' results are graphically represented and compared. [Figure 10](#) shows an example of results for west oriented façade. The full report shows all the detailed results of the calculations and measurements in the five points of each room in each of the three façades.

The conclusions can be summarised as follows:

- The automatic control system in the CONTINUOUS scenario gives the best results for maximum daylight. In the first two measuring points, closest to the window, the results are as good as, or better than, the performance obtained by the most frequent users (Maxi). In the centre of the rooms, the autonomy drops slightly but remains better than the 'median' manual result. In the back of the room (point 5) the results are similar to the median values.
- The automatic system, in the RESET scenario, has slightly lower performances: in points 1 and 2, the level about 10% lower, while in the back of the room, the level is similar to the median value.
- Compared with a median user, the CONTINUOUS scenario reduces by 20% the number of hours that the lights are switched on, for an illumination level of 500 Lux.
- In the same comparison, the RESET scenario allows a reduction of 17% in the number of hours of switched-on lights.

4.7.2 An illumination level of 150 Lux

As we have seen, users often only switch on the lights at levels much lower than the legally required - 500 Lux. Therefore, we have analysed the situation where the user switches on the lights when the illumination level reaches 150 Lux and switches them off when they leave work, at 13 h or at 18 h.

The full report shows these results in detail:

- The two automatic control systems bring significant gains
- Compared to the median value of manual operation, the reduction of the number of hours 'lights switched on' in the CONTINUOUS system is appr. 35%
- Compared to the RESET scenario, the reduction is 27%.

4.8 Study of alternative solar shading systems

4.8.1 Venetian blinds: influence of the colour of the slats

Simulations have been made in the CONTINUOUS scenario in order to determine the influence of the colour of the slats. The reference case is the existing situation: slats with a measured reflectance factor of $r = 0.30$. The simulations have been made for three alternative colours: dark ($r = 0.10$), light colour ($r = 0.50$) and very light ($r = 0.70$) and for each of the façades, for the Auto₅₀₀ situation. The conclusions are:

- Close to the window, the colour or brightness of the slats has no influence on the amount of natural daylight
- Deep into the room, the influence is weak
- A greater spread is found in the south-oriented building, probably because the slats are more often in the horizontal position (sun is high on south) and the light is more easily reflected inside.

4.8.2 Solar blinds equipped with solar shading fabrics

Simulations were made for roller blinds with three types of solar control fabrics:

- fabric 1, a light-coloured (white-sand, Diffuse transmittance = 8%, direct transmittance 10%, reflectance 52%),
- a slightly denser fabric 2 (linen, Diffuse transmittance = 6%, direct transmittance 4%, reflectance 53%),
- and a grey-white black-out blind, fabric 3 (transmittance 0%, reflectance 43%).

For the three façades, the blind movements have been simulated to follow the same 5 scenarios (3 'manual', 2 'automatic') for the Auto₅₀₀ case. The conclusions are as follows:

- For the harvesting of natural daylight, the blinds with fabrics systematically show a lower performance than the venetian blinds,
- However, the light-coloured fabric 1 comes close to the performance of the venetian blinds, especially for the east and west façades,
- As expected fabric 2 did not perform as well as fabric 1,
- Obviously fabric 3 does not allow any light ingress.

4.8.3 Glazing with variable transmittance

The colour of this type of glazing (e.g. SageGlass) can be adjusted, automatically or manually, to the exterior level of light. The transmittance factor can be reduced to 1%. As an alternative to traditional solar shading, this solution may be of interest for renovation projects of historic buildings or buildings of great height, where other shading solutions may not be appropriate or possible. Each window of this type of glass can have up to three separate and individually adjustable zones, for optimum user comfort. Again, simulations were made for the two cases (Continuous and Reset automated), and compared to manual maxi, median and mini users for three orientations, each time for the Auto₅₀₀ requirement. The conclusions are:

- The 2- and 3-zone glazing comes close to the performance of the venetian blinds (Continuous scenario). The gap in the results is mainly due to the transmittance factor of the glass
- The comparison with a glazing with a visible light transmittance of 60% (e.g. Triple glass or double solar control glass) shows that the variable transmission glazing can give results identical with automated venetian blinds
- The one-zone version systematically gives lower results than even the median manual scenario.

5. Electricity consumption for lighting

In this chapter we will evaluate the consumption of electricity for artificial lighting by comparing the calculation according to Standard 380/4 (Swiss standard) with the simulations made on the basis of the observations.

The installation of artificial lighting

The installed power for a standard office is 13.8 W/m² delivered by 4 ceiling grids of 68% yield, each holding two 35W fluorescent lamps of 87 lm/W and an electronic ballast of 3 W.

Solar protection levels

The Swiss SIA standards give a definition of the degree of protection of solar shading blinds (1st, 2nd and 3rd degree) depending on the reflectance factor and the operating mode. We have associated these three degrees with:

- Degree 1: motorised with automation
- Degree 2: motorised without automation
- Degree 3: manual blinds (the base case for this study).

5.1 Case n° 1: no automation

The calculation of lighting electricity according to Standard SIA 380/4 shows, for this case, an annual consumption of 34.9 kWh/m².a.

Simulations with a trigger threshold of 150 Lux and switch-off during the breaks show a different picture: 30% less than the Standard suggests, for the scenarios “manual median” (24.5 kWh/m².a instead of 34.9 kWh/m².a, see Figure 11 and Table 1).

- We therefore conclude that the standard calculation to the present standard is very pessimistic with no automation,

5.2 Case n° 2: automation of blinds only

The blinds are automated, the lighting is manual. The calculation to Standard SIA 380/4, in protection degree 1, shows an annual power consumption of 29.7 kWh/m².a. Otherwise stated, a simple automated system already enables a reduction of energy consumption of up to 15% (29.7 compared to 34.9 kWh/m².a).

Our simulations according to the year-long observations, however, show substantially higher number: in the CONTINUOUS scenario, it shows a 47% saving (15.8 instead of 34.9 kWh/m².a, see Figure 11 and Table 1).

- **This means that the Standard is extremely pessimistic.**

5.3 Case n° 3: automation of lighting: automatic on/off

The SIA 380/4 calculation results in a power consumption of 27.6 kWh/m².a, a reduction of 21% (compared to 39.4) just by installing a simple on/off automated system. If we assume that such a system will switch on the lights as soon as the Illuminance drops below 500 Lux, the power consumption will be an addition to the Auto₅₀₀ autonomy hours above 500 Lux, referred to earlier.

Here we find that the simulations show a higher electricity use than SIA 380/4 suggests, (33.3 instead of 27.6 kWh/m².a, see Figure 11 and Table 1).

- Here, the standards clearly are too optimistic.

5.4 Case n° 4: automation of both lighting (on-off) and blinds

The SIA 380/4 calculation in this case results in a power consumption of 24.5 kWh/m².a, appr. 11% lower than case n° 3.

The simulations show in the CONTINUOUS scenario a value of 26.6 kWh/m².a, or 9% more, in RESET 27.7 kWh/m².a or +13% (weighted for the number of windows of each façade).

- This means that the CONTINUOUS scenario is relatively close to the SIA numbers (-2.1 kWh/m².a or -8.5%, see Figure 11 and Table 1).

5.5 Case n° 5: automation of the lighting: auto-off

In this case, the lighting is automatically switched off when 500 Lux is reached but will not switch on again. SIA 380/4 results in 25.8 kWh/m².a, or 26% below the base case n° 1.

In the simulation procedure, we assume that the user switches the lights on when the level drops below 150 Lux while they will be switched off automatically when 500 Lux is reached (during office hours 7h till 18h). The result is 22.2 kWh/m².a or -14% in the Manual Median case (see Figure 11 and Table 1).

- We can conclude that the SIA 380/4 result is close enough to the observations, with a gap of +3.6 kWh/m².a for the Median case.

5.6 Case n° 6: automation auto-off of lighting and of blinds

Compared to case n°5, the standards assume that the blinds will be automatically moved which results in a slight reduction of power use: 23.2 kWh/m².a instead of 25.8, or about 10% less.

The simulations based on the observations show substantial savings: in CONTINUOUS -49% (at 12.4 kWh/m².a) and in RESET -40% at 14.7 kWh/m².a.

- Here we find that the standard is extremely pessimistic, while the difference between the theoretical consumption and the CONTINUOUS scenario is +10.8 kWh/m².a, almost half of what the standards suggest.

5.7 Case n° 7: automation of lighting, dimming without stand-by

In this case, the automation will maintain an illumination level of 500 Lux: e.g.: if the level drops to 400 Lux, the system will feed an additional of 100 Lux. Calculations show that the power consumption will be 27.6 kWh/m².a, a reduction of 21% and a result very similar to Case n° 3 (AUTO on/off).

Simulations for the three façades, based on the observations, show a significant difference for the weighted average of the autonomy values in the centre of the rooms in Manual Median (-26% at 20.5 kWh/m².a, see Figure 11 and Table 1).

- Here again, the calculation with the Standard is very pessimistic and the difference with the Manual Median scenario is +7.1 kWh/m².a.

5.8 Case n°8: automation of lighting (dimming) and of blinds

The comparison with case n° 7 shows that the standards expect that an automation of the blinds will result in approx 11% lower electricity consumption: 24.5 kWh/m².a instead of 27.6 kWh/m².a.

Again, our simulations show much better results: -48% for CONTINUOUS, at 12.6 kWh/m².a and -40% for RESET at 14.6 kWh/m².a.

- The standard 380/4 again is extremely pessimistic, the difference between the theoretical calculation and the CONTINUOUS automation being almost one half at +11.9 kWh/m².a.

5.9 Summary of the energy consumption calculations

The figure below gives an overview of the calculations and simulations for the various cases.

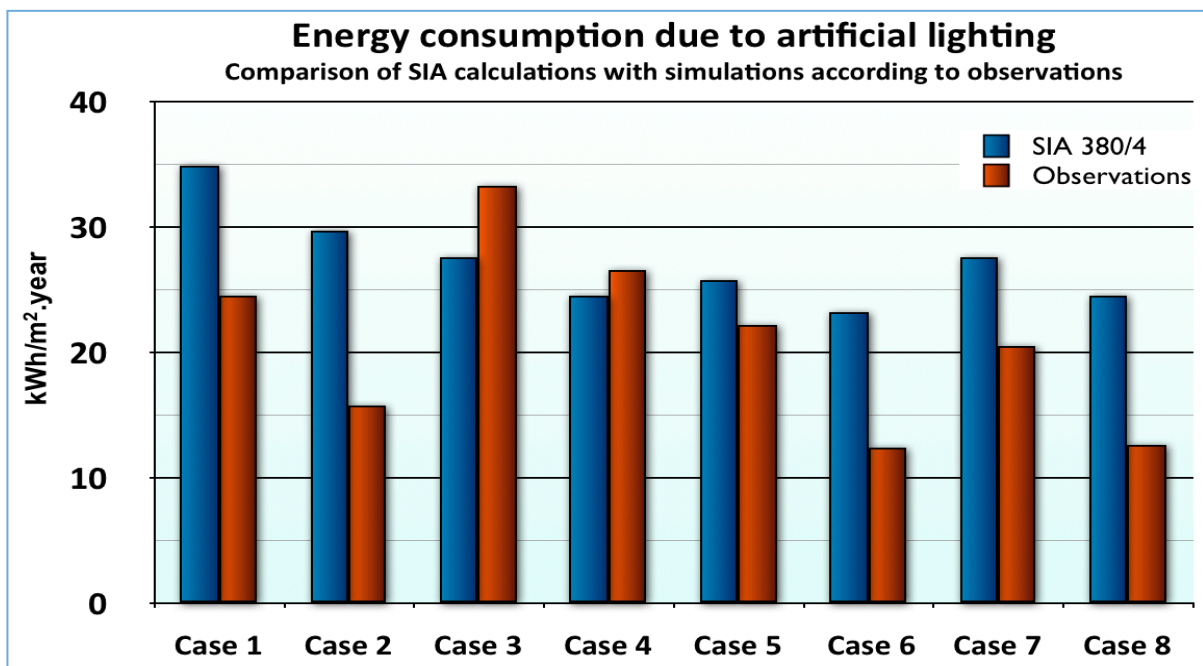

Figure 11: Energy consumption for lighting: comparison between the calculations with the Swiss Standard SIA 380/4 (blue) and the simulations based on observations (red, median values).

| | Artificial lighting | Blinds | SIA380/4 | Observation |
|----------|--------------------------|-----------|-------------|-------------|
| Case n°1 | Manual | Manual | 34.9 | 24.5 |
| Case n°2 | Manual | Automated | 29.7 | 15.8 |
| Case n°3 | Automatic on & off | Manual | 27.6 | 33.3 |
| Case n°4 | Automatic on & off | Automated | 24.5 | 26.6 |
| Case n°5 | Automatic off | Manual | 25.8 | 22.2 |
| Case n°6 | Automatic off | Automated | 23.2 | 12.4 |
| Case n°7 | Dimming without stand-by | Manual | 27.6 | 20.5 |
| Case n°8 | Dimming without stand-by | Automated | 24.5 | 12.6 |

Table 1: Summary of power consumption in kWh/m².a for the various cases and scenarios

The conclusion is clear: with the exception of cases 3 and 4, the calculations as required by the Norm 380/4 result in a much higher energy consumption prediction than the simulations, often with a wide margin. The calculation method according to the norm is pessimistic or even very pessimistic, except for the case of the automation on/off.

6. Evaluation of the results

The solar shading blinds and their operation

This study clearly shows that automation of solar shading blinds offers an important potential for the use of natural daylight.

- The number of moves of the blinds is extremely low: 1.74 per week on average. Only 12% of the users change the position of the blind every day, while 41% make less than one movement per week.
- The average percentage of the glazing that is covered by the blinds is very important: up to 75% of the glass surface is covered by the blinds on the south façade. Some users leave their blinds 'up' most of the time, while others leave them 'down'. This creates big differences in the need for adequate light levels.
- The orientation plays a major role and has an influence on the use of daylight and on the power consumption for artificial light. The variation is highest on the west façade which explains why the tilt angle of the slats is changed more often, the sun being on the descent. The east façade has a much lower variation.
- The quantitative influence of the colour of the slats is low, though the use of dark-coloured slats creates a visual barrier and reduces the user's comfort.
- Blinds equipped with fabric, as opposed to slats, except for black-out blinds, show a potential similar to venetian blinds.
- Variable transmittance glazing shows a potential similar to venetian blinds, if the colour is controlled by zone.
- The potential savings from automation of the solar shading blinds are very high for the two first points of the rooms (closest to the window), high in the centre and moderate in the back of the rooms. The CONTINUOUS automation system (hourly adaptation of the blind up or down) allows a gain of several hundred hours of natural light reducing the electricity consumption for artificial lighting up to 35%. The RESET system has a slightly lower performance than CONTINUOUS on the south and east façades, but is equivalent on the west side. On average, the difference is about 10%. The RESET system however is less intrusive and is likely to be more acceptable to the occupants.

7. Conclusions and perspectives

7.1 Review of Standard SIA 380/4

- Without automation: It appears from this study that the calculation according to the SIA Standard is very pessimistic in the absence of automation. We observed that the users will not switch on the lights until the light level is very low. That reduces power consumption. The predicted consumption without automation should therefore be reduced by 20% to 35%.
- Automation of lighting only: this study shows that an on-off automation of artificial lighting is probably counter-productive because it considerably increases the number of "lights on" hours when the blinds are not automated, as a consequence of the poor operation of the blinds.
- Automation of blinds only: the energy savings potential from automating the blinds is very high, even without automating the artificial lighting. Therefore, the SIA Standard should encourage the automation of solar shading blinds as a priority, in order to realise the savings on the energy consumption for the lighting system.
- Automation of both lighting and blinds: the SIA calculation is pessimistic to very pessimistic for this scenario. The scenarios auto/off and continuous dimming with automation of the blinds shows a large variation between the calculations to the Standard and the simulations based on our observations. The Standard should take this into account.
- The study makes recommendations for the revision of the Standard relative to the solar shading systems.
- Natural light potential in the Standard: according to the results of this study, the Standard does not take sufficient account of the potential of natural diffuse light, as a source of free and renewable energy. This should be revised and the Standards should comprise specific requirements for the optimum use of natural daylight.

7.2 National and international collaborations for this study

- HES Luzern: this study will serve as a basis for experimental work at Haute Ecole Lucerne. We particularly recommend the verification with the test-users of the benefit in the late afternoon of switching on the lighting
- Sage-Glass made data available on variable transmission glass
- Blinds with solar shading fabrics: photometric information made available by Mermet SA
- IEA: the results of this study will be integrated in the work of Task 50 of the International Energy Agency (IEA-SHC Task 50 <http://task50.iea-shc.org> "Advanced Lighting Solutions for Retrofitting Buildings").

7.3 Perspectives

The observation during 12 consecutive months has resulted in a considerable collection of data. These data have so far been analysed and used for information on the **lighting** of the rooms and have allowed conclusions on the real-life use of non-automated solar shading blinds. To complete the study and its conclusions, it would be necessary to analyse the consequences of the automation of the blinds on the **thermal** behaviour of the building. In particular, the automation system RESET has focused here only on the maximum use of natural daylight, but should also be modified to integrate thermal objectives, especially the reduction of the risk of overheating in summer conditions.

8 References

- Paule, B. Boutillier, J. & Pantet, S. (2014): Global lighting performance, Annual report 2013-2014. Project 81 0083 : Swiss Federal Office for Energy, Lausanne, 2014.
- L'énergie électrique dans le bâtiment, Norme Suisse 520 380/4, 2006.
- Sutter, Y. (2003). Etude analytique et expérimentale du pilotage de stores vénitiens en vue d'obtenir des conditions de confort visuel optimales dans le cas du travail sur écran de visualisation [Analytical and experimental study of the control of venetian blinds to obtain optimum visual comfort conditions in the case of work with visual display] (Unpublished doctoral dissertation or master's thesis). Institut National des Sciences Appliquées de Lyon, France.
- Monitoring manual control of electric lighting and blinds, Lighting Research and Technology 35 (3), 243-260, Reinhart, C.F. & Voss, K. (2003).
- Occupant preferences and satisfaction with the luminous environment and control systems in daylight offices: A literature review, Energy and Buildings, v. 38, 728-742, Galasiu A.D. & Veitch, J.A. (2006);
- Patterns of occupant interaction with window blinds: A literature review, Energy and Buildings, Volume 51, 165-176, Van Den Wymelenberg, K. (2012).
- Manually-operated window shade patterns in office buildings: A critical review. Building and Environment, 60, pp.319-338, O'Brien, W., Kapsis, K. & Athienitis, A.K., 2013.
- Building automation and perceived control: A field study on motorized exterior blinds in Dutch offices, Building and Environment, Volume 79, Pages 66-77 Meerbeek, B. Te Kulve, M., Gritti, T., Aarts, M., Van Loenen, E., Aarts, E. (2014).
- CSN EN 15251 (2007), Indoor environmental input parameters for design and assessment of energy performance of buildings- addressing indoor air quality, thermal environment, lighting and acoustics. Release 2007.
- DIAL+Suite (Version 2.0) [Computer software] Lausanne, Estia SA. www.dialplus.ch
- Paule, B. Florentzos, F., Pantet, S. & Boutillier, J. (2011, September). DIAL+Suite: A complete but simple suite of tools to optimize the global performance of building openings : Daylight / Natural Ventilation / Overheating Risks. Proceedings of the CISBAT'11 Conference, Lausanne, Switzerland, Sept. 2011.