

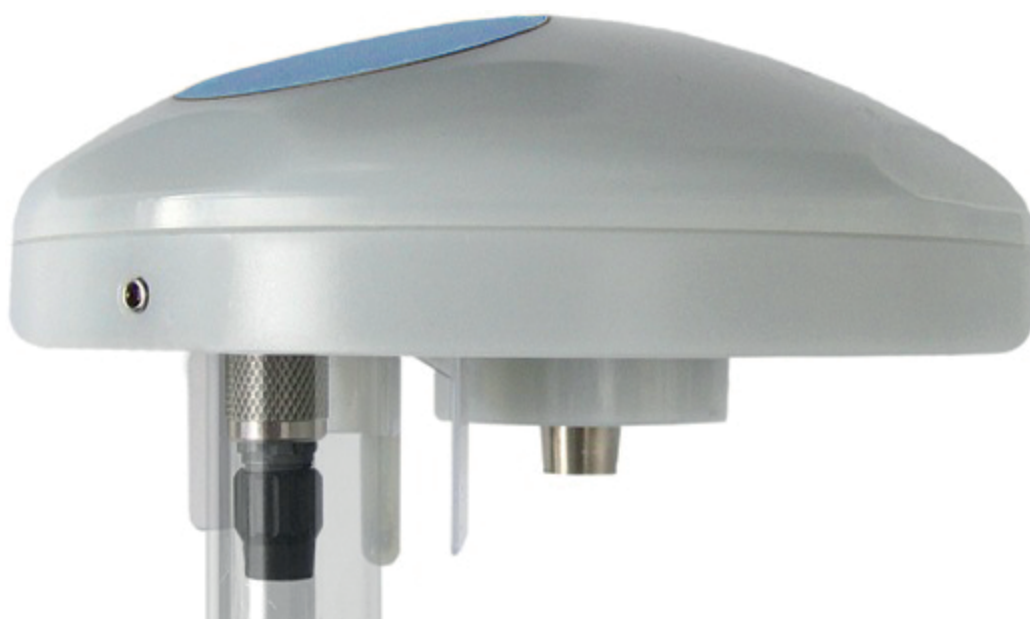

Product documentation

Weatherstation KNX
Art. No. 1870932



Somfy Activités SA
70 Avenue du Nouveau Monde
74300 Cluses
France

www.somfy.com
www.somfy.com/projects

© 2021
SOMFY ACTIVITES SA
Société Anonyme
Capital 35.000 000 €
RCS Annecy 303.970.230

Issue: 16.02.2021
5158799A

1	Product definition	4
1.1	Product catalogue	4
1.2	Function	4
1.3	Accessories	5
2	Mounting, electrical connection and operation	6
2.1	Safety instructions	6
2.2	Device components	7
2.3	Fitting and electrical connection	8
2.4	Commissioning	15
2.5	Programming LED	16
3	Technical data	17
4	Software description	19
4.1	Software specification	19
4.2	Software "KNX Weather station"	20
4.2.1	Scope of functions	20
4.2.2	Data points	21
4.2.2.1	Object table "Disabling modules"	23
4.2.2.2	Object table "Logic gates"	25
4.2.2.3	Object table "Shading control"	27
4.2.2.4	Object table "Brightness sensor"	30
4.2.2.5	Object table "Twilight sensor"	31
4.2.2.6	Object table "Wind speed"	32
4.2.2.7	Object table "Wind direction"	33
4.2.2.8	Object table "Precipitation"	34
4.2.2.9	Object table "Absolute humidity"	35
4.2.2.10	Object table "Relative humidity"	36
4.2.2.11	Object table "Temperature sensor"	37
4.2.2.12	Object table "Felt temperature"	38
4.2.2.13	Object table "Comfort"	39
4.2.2.14	Object table "Air pressure"	40
4.2.2.15	Object table "Global radiation"	41
4.2.2.16	Object table "GPS/Glonass"	42
4.2.2.17	Object table "Monitoring"	43
4.2.2.18	Object table "Limiting value"	45
4.2.2.19	Object table "External limiting values"	46
4.2.3	Functional description	54
4.2.3.1	Application-oriented functional description	54
4.2.3.2	Disabling modules	62
4.2.3.3	Logic gates	63
4.2.3.4	Shading control	66
4.2.3.5	Sensor functions	73
4.2.3.5.1	Brightness	74
4.2.3.5.2	Twilight	75
4.2.3.5.3	Wind	76
4.2.3.5.4	Precipitation	79

4.2.3.5.5	Air humidity	80
4.2.3.5.6	Temperature	81
4.2.3.5.7	Comfort	83
4.2.3.5.8	Air pressure	85
4.2.3.5.9	Global radiation	86
4.2.3.5.10	GPS/Glonass	87
4.2.3.6	Measured and limiting values	88
4.2.3.7	Delivery state	97
4.2.4	Parameters	98
4.2.4.1	Parameter group "General"	98
4.2.4.2	Parameter group "Time"	101
4.2.4.3	Parameter group "Disabling modules"	104
4.2.4.4	Parameter group "Logic gate"	106
4.2.4.5	Parameter group "Shading control"	109
4.2.4.6	Parameter group "Brightness sensor"	116
4.2.4.7	Parameter group "Twilight sensor"	123
4.2.4.8	Parameter group "Wind speed"	130
4.2.4.9	Parameter group "Wind direction"	136
4.2.4.10	Parameter group "Precipitation"	143
4.2.4.11	Parameter group "Absolute humidity"	146
4.2.4.12	Parameter group "Relative humidity"	152
4.2.4.13	Parameter group "Temperature sensor"	158
4.2.4.14	Parameter group "Felt temperature"	165
4.2.4.15	Parameter group "Comfort"	172
4.2.4.16	Parameter group "Air pressure"	173
4.2.4.17	Parameter group "Global radiation"	179
4.2.4.18	Parameter group "GPS/Glonass"	185
4.2.4.19	Parameter group "Monitoring"	186
5	Appendix	188
5.1	Index	188

1 Product definition

1.1 Product catalogue

Product name: Weatherstation KNX

Use: Physical sensor

Design: Surface-mounted device for outdoor installation

1.2 Function

Function

The KNX weather station detects the meteorological data "Wind speed", "Wind direction", "Precipitation", "Global radiation", "Temperature", "Twilight", and "4 directions of brightness". In addition, the "relative humidity" and "air pressure" are measured. The position of the mounting location of the weather station can be determined via GPS.

The "maximum value of the brightness sensors", the "absolute humidity", "felt temperature" and "comfort" are calculated using the acquired data.

- i The measured values apply to the mounting location. Variations to other weather services – e.g. through local turbulence or areas with build-ups of air – are possible.

The main area of application is automatic, weather-independent control of shading. It is specially designed for use in homes. To increase function safety, the weather station monitors some key functions itself and automatically signals appropriate errors to the bus using signal objects.

Using the values measured by the weather station, which can be sent to the bus via communication objects, the appropriate bus subscribers can control weather-dependent processes and can also visualise the climate or display specific measured values.

The weather station intended for external mounting on a mast or on the wall.

There is an integrated bus coupling unit to the KNX/EIB (Monoblock).

Evaluation of the data, in particular limiting value processing, takes place in the weather station.

An integrated heater provides protection against function restriction due to frost or dew down to -20 °C. In addition, the heater protects the sensor surface of the precipitation sensor by providing quick drying after rain and thawing in case of snow and ice.

The weather station requires an external 24 V AC/DC power supply to supply the unit. The applied voltage can be monitored. The failure of the external power supply is then signalled to the bus via a communication object.

Logic gates are available in order to cascade multiple weather stations or to gate the limiting values and the monitoring functions.

Disabling modules make it possible to block individual functions on site.

1.3 Accessories

animeo Power Supply DC

Order No. 1860093

2 Mounting, electrical connection and operation

2.1 Safety instructions

Electrical equipment may only be installed and fitted by electrically skilled persons. The applicable accident prevention regulations must be observed.

Make sure during the installation that there is always sufficient insulation between the mains voltage and the bus. A minimum distance of at least 4 mm must be maintained between bus conductors and mains voltage cores.

Before working on the device or exchanging the connected loads, disconnect it from the power supply (switch off the miniature circuit breaker), otherwise there is the risk of an electric shock.

The device may not be opened or operated outside the technical specifications.

Failure to observe the instructions may cause damage to the device and result in fire and other hazards.

2.2 Device components

Device components

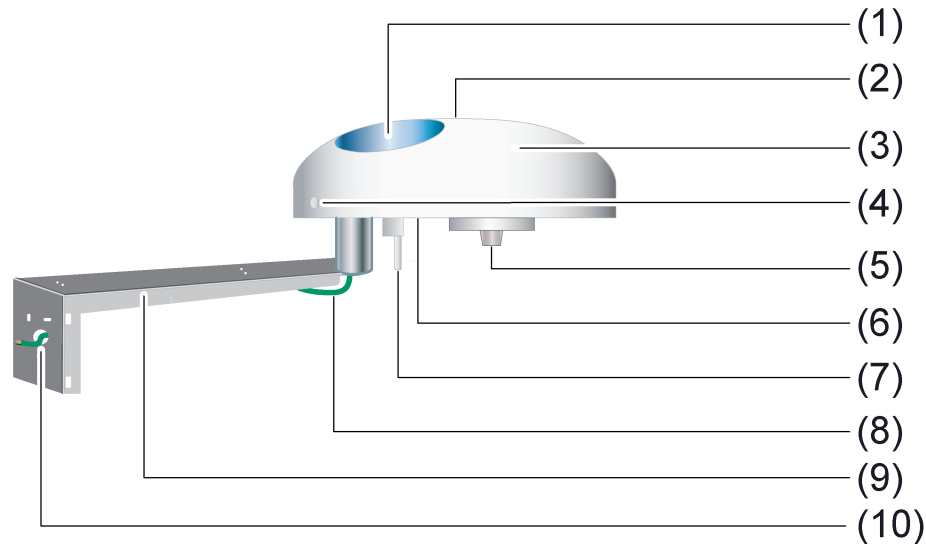

Figure 1: Structure of the weather station

- (1) Capacitive sensor surface of the precipitation sensor
- (2) Light guide to a PIN photo diode to measure the global radiation
- (3) Translucent sensor head with the sensor surface of the precipitation sensor, the temperature sensor, the sensor for measuring global radiation, a thermosensor, the GPS/GLONASS receiver, the wind direction and wind speed sensor and the 4 brightness sensors
- (4) Allen screw to fasten the weather station on a pipe support. At the same time, this screw serves to mark where north is.
- (5) Position of the thermal sensors to determine the wind speed and the wind direction.
- (6) Sensor for measurement of the relative air humidity
- (7) Location of the temperature sensor
- (8) Outlet of the power supply line
- (9) Fastening arm for orientating the sensor head
- (10) Cable outlet of the fastening arm

Dimensions approx.: Height 67.5 mm, diameter 130 mm

- i** The supplied magnet is used to program the weather station.
- i** The air guidance planes supplied with the weather station are used to avoid wind eddies. These should be mounted at the intended locations on the underside of the weather station only when it is mounted on a mast.

2.3 Fitting and electrical connection

Selecting installation location

- Select a mounting location in which the weather station is not influenced by local obstacles or shading, such as surrounding trees, chimneys, awnings, etc. The sensor must be able to detect wind, rain and ambient brightness without impedance.
- ❗ Do not mount it below or next to building sections, from which water can drip onto the device.
- ❗ Select the mounting location so that the weather station will be accessible.
- ❗ In the case of flat roofs, locate the weather station as close to the centre of the roof as possible.
- ❗ Minimum distance to surface beneath the weather station: 0.6 m. Otherwise, the sensors on the underside may get damaged by penetrating spray water.

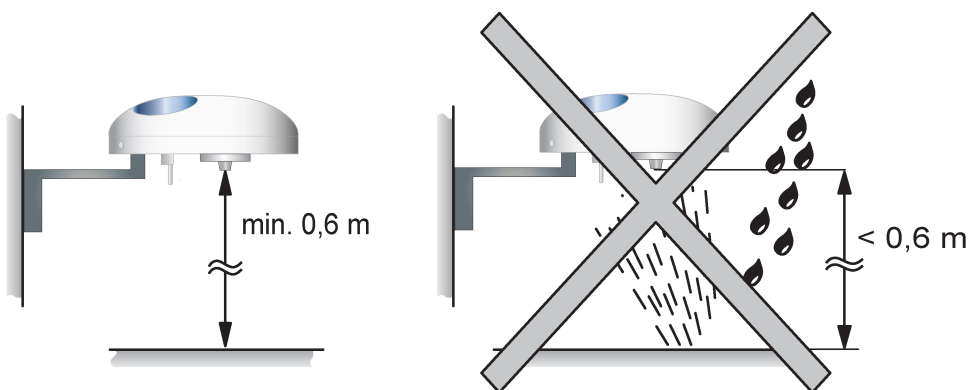

Figure 2: Minimum distance to surfaces

- ❗ Direct sunlight, chimneys or other waste gas or ventilation systems affect the temperature measurement.
- ❗ Do not operate in the vicinity of radio transmitter systems. Doing so will compromise function.
- ❗ Mast mounting with fastening arm and hose clamps or directly on the open end of the mast.

Mounting and connecting the device

- ❗ In the planning phase of the electrical system, comply with the valid lightning protection regulations. Have an electrical installation engineer check the inclusion of the weather station in a lightning protection system.
- ❗ In a KNX system, the maximum number of three weather stations per line may not be exceeded.



DANGER!

Electrical shock when live parts are touched.

Electrical shocks can be fatal.

Before working on the device, disconnect the power supply and cover up live parts in the working environment.

A fastening arm, two hose clamps and the necessary screws and anchors (S6) are provided for mounting the weather station. These items are used to fasten the weather station, for example to the wall of a building.

The most suitable mounting option is to mount the weather station directly on a free-standing mast. Ensure that the diameter of the mast is suitable. The external diameter may not exceed 25 mm. By contrast, the internal diameter must be greater than 19 mm, so that the plug can be passed through. In addition, mount the supplied air guidance planes when mounting on a mast. An additional mounting option is to fasten the fastening arm to a mast using two hose clamps. The enclosed hose clamps are suitable up to an external mast diameter of 60 mm.

Besides the fastening arm and the hose clamps, the scope of delivery of the weather station also contains a preterminated power supply cable. This 5 metre-long, 4-wire cable is prepared with a plug for connection to the weather station. This connects both the KNX and the 24 V power supply.

The stripped ends of the power supply cable of the weather station are given wire end ferrules during delivery, so that the individual cables (orange = AC/DC 24 V ~/+; brown = AC/DC 24 V ~/-; red = KNX +; black = KNX -) can be connected to the power supply and/or the KNX using four spring terminals (e.g. Wago - Series 222). Ensure that the electrical cables are combined in suitable junction boxes. Select these junction boxes according to the mounting location and the prevailing environmental conditions.

Mounting and connecting the device - Mounting without fastening arm on freestanding mast



DANGER!

Electrical shock when live parts are touched.

Electrical shocks can be fatal.

Before working on the device, disconnect the power supply and cover up live parts in the working environment.

The weather station can be fastened directly to the end of a mast.

The weather station is mounted directly on the end of a mast.

- i** Mounting the weather station on a mast is the most suitable mounting type, as the weather station can then record brightnesses, wind and temperature, without any interference from structural obstacles.

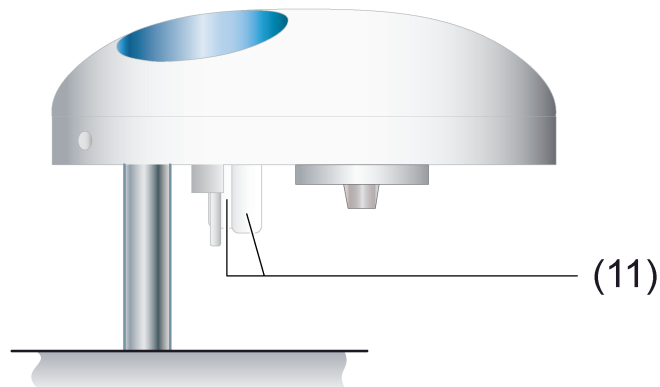

Figure 3: Mounting of the weather station on a freestanding mast

(11) Air guidance planes against wind eddies for mounting on the end of a mast

- Firstly, mount the two supplied air guidance planes in the recesses on the base of the weather station using the enclosed screws.
- Connect the 7-pin plug of the power supply cable to the corresponding socket on the base of the weather station.
- Route the cable through the mast.
- Mount the weather station onto the mast and align it to the north.

i The Allen screw serves as a mark of the side of the weather station to be aligned to the north.

- Tighten the weather station sufficiently using the Allen screw (0.6 Nm).
- Route the cable for the power supply and bus connection through the cable gland (10) into an installation pipe for the purpose.
- Connect the open end of the power supply cable to the KNX power supply using the red (KNX +) and black (KNX -) wire pair. Also, use the orange (AC/DC 24 V ~/+) and brown (AC/DC 24 V ~/-) wire pair to connect to the external 24 V power supply.
- Connect the power supply.
- Connect the KNX bus line.

i The external diameter of the mast may not exceed 25 mm. By contrast, the internal diameter must be greater than 19 mm, so that the plug can be passed through.

i The sensor head (3) is translucent to enable brightness measurements. Therefore, do not stick or write on the sensor head (3). This can lead to measurement errors.

i The stripped ends of the power supply cable of the weather station are given wire end ferrules during delivery, so that the individual cables (orange = AC/DC 24 V ~/+; brown = AC/DC 24 V ~/-; red = KNX +; black = KNX -) can be connected to the power supply and/or the KNX using four spring terminals (e.g. Wago - Series 222). Ensure that the electrical cables are combined in suitable junction boxes. Select these junction boxes according to the mounting location and the prevailing environmental conditions.

Mounting and connecting the device - Mounting on a wall or mast



DANGER!

Electrical shock when live parts are touched.

Electrical shocks can be fatal.

Before working on the device, disconnect the power supply and cover up live parts in the working environment.

The weather station is mounted on a mast using the hose clamps attached to the fastening arm.

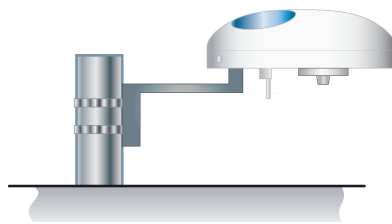

Figure 4: Mounting of the weather station on a mast

- Route the enclosed hose clamps through the recesses on the fastening arm.
- Run the hose clamps mounted on the fastening arm around the mounting mast and then tighten them at the required height.
- Connect the 7-pin plug of the power supply cable to the corresponding socket on the base of the weather station.
- Route the cable through the open pipe socket at the end of the fastening arm.
- Mount the weather station onto the pipe socket and align it to the north.

i The Allen screw serves as a mark of the side of the weather station to be aligned to the north.

- Tighten the weather station sufficiently using the Allen screw (0.6 Nm).
- Route the cable for the power supply and bus connection through the cable gland (10) into an installation pipe for the purpose.
- Connect the open end of the power supply cable to the KNX power supply using the red (KNX +) and black (KNX -) wire pair. Also, use the orange (AC/DC 24 V ~/+) and brown (AC/DC 24 V ~/-) wire pair to connect to the external 24 V power supply.
- Connect the power supply.
- Connect the KNX bus line.

i The enclosed hose clamps can be used up to a maximum mast diameter of 60 mm.

i During mounting and operation of the weather station, ensure that the vertical and lateral loads do not become too great, as the fastening arm may otherwise break.

i The sensor head (3) is translucent to enable brightness measurements. Therefore, do not stick or write on the sensor head (3). This can lead to measurement errors.

- i** The stripped ends of the power supply cable of the weather station are given wire end ferrules during delivery, so that the individual cables (orange = AC/DC 24 V ~/+; brown = AC/DC 24 V ~/-; red = KNX +; black = KNX -) can be connected to the power supply and/or the KNX using four spring terminals (e.g. Wago - Series 222). Ensure that the electrical cables are combined in suitable junction boxes. Select these junction boxes according to the mounting location and the prevailing environmental conditions.

The weather station is fastened on a wall using the fastening arm.

- Attach the fastening arm enclosed with the weather station to a suitable wall. In so doing, always ensure the minimum distance to the surfaces beneath (figure 2).
- Fasten the mounting bracket arm to the wall through the punched out boreholes (figure 5) using suitable screws.

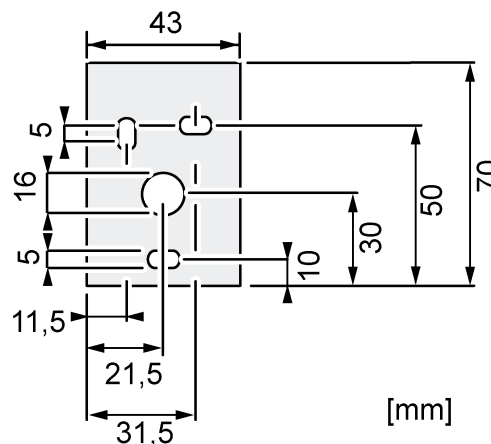

Figure 5: Template of drillholes and cable penetration

- Connect the 7-pin plug of the power supply cable to the corresponding socket on the base of the weather station.
- Route the cable to be connected through the open pipe socket at the end of the fastening arm.
- Mount the weather station onto the pipe socket and align it to the north.

- i** The Allen screw serves as a mark of the side of the weather station to be aligned to the north.
- To fasten the weather station, tighten the Allen screw sufficiently with a torque of 0.6 Nm.
 - Route the cable for the power supply and bus connection through the cable gland (10) into an installation pipe for the purpose.
 - Connect the open end of the power supply cable to the KNX power supply using the red (KNX +) and black (KNX -) wire pair. Also, use the orange (AC/DC 24 V ~/+) and brown (AC/DC 24 V ~/-) wire pair to connect to the external 24 V power supply.
 - Connect the power supply.
 - Connect the KNX bus line.

During mounting and operation of the weather station, ensure that the vertical and lateral loads do not become too great, as the fastening arm may otherwise break.

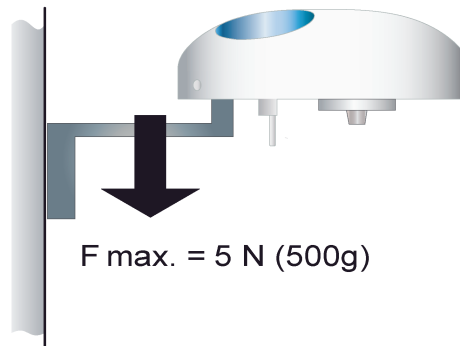

Figure 6: Maximum load on the fastening arm of the weather station

- i** Of the three mounting types, wall mounting is the least suitable, as more or less unavoidable shadows will impede at least one brightness sensor and the wind measurement.
- i** The sensor head (3) is translucent to enable brightness measurements. Therefore, do not stick or write on the sensor head (3). This can lead to measurement errors.
- i** The stripped ends of the power supply cable of the weather station are given wire end ferrules during delivery, so that the individual cables (orange = AC/DC 24 V ~/+; brown = AC/DC 24 V ~/-; red = KNX +; black = KNX -) can be connected to the power supply and/or the KNX using four spring terminals (e.g. Wago - Series 222). Ensure that the electrical cables are combined in suitable junction boxes. Select these junction boxes according to the mounting location and the prevailing environmental conditions.

Orienting the weather station

The weather station should be aligned to the north. The Allen screw for fastening the weather station serves an orientation aid here. For the most accurate determination of the wind direction and brightness, this Allen screw should be aligned to the north.

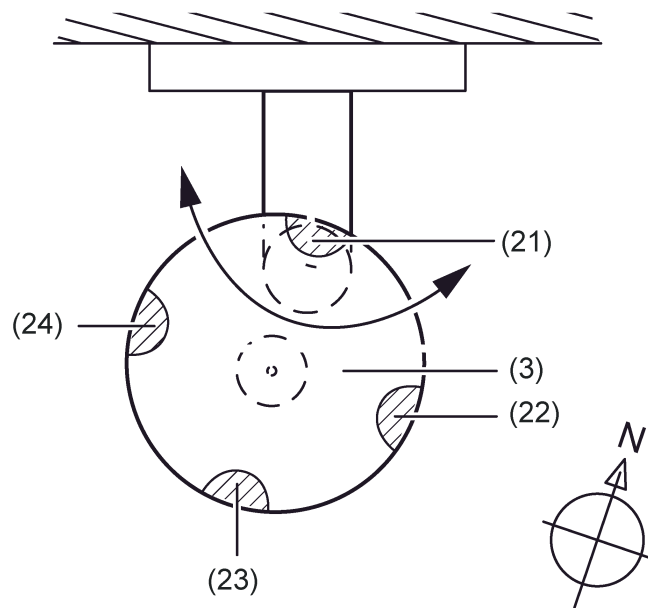

Figure 7: Orientation of the weather station

- (3) Sensor head
- (21) Brightness sensor 1
- (22) Brightness sensor 2
- (23) Brightness sensor 3
- (24) Brightness sensor 4

Orientation in the compass directions:

- Using a compass, align the device in such a way that the Allen screw for fastening the weather station, and thus the brightness sensor 1 (21), points north.
- ❗ Without correct orientation, the assignment of the brightness sensors to the compass directions north, east, south and west cannot be guaranteed.
- ❗ Select this orientation if 4 or more sides of the building are to be shaded.
- ❗ Select this orientation if a side faces approximately to the south.

2.4 Commissioning

Commissioning the device



DANGER!

Electrical shock when live parts are touched.

Electrical shocks can be fatal.

Before working on the device, disconnect the power supply and cover up live parts in the working environment.

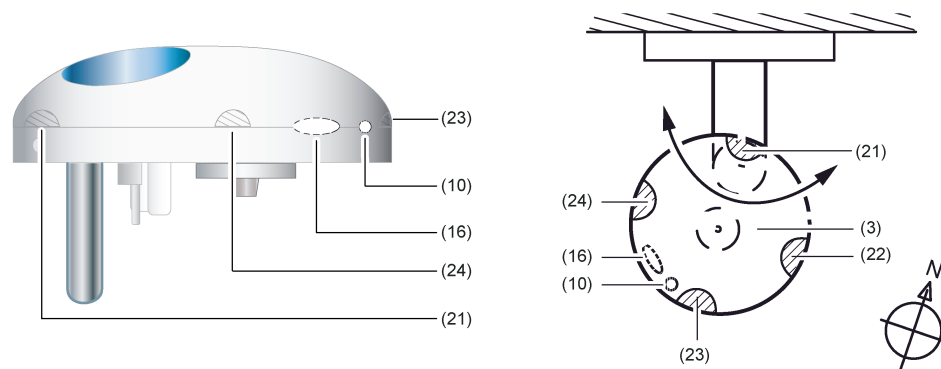

Figure 8: Operating elements

(10) Position of the programming LED

(16) Position of the reed contact

- Switch on the bus voltage.
- Switch on supply voltage.
- Hold the supplied programming magnet by the integrated reed contact (16).
The programming LED (10) lights up blue. Programming mode is activated.
- ⓘ The programming LED shines through the translucent housing of the sensor head, and is not visible when not lit up.
- Assign physical addresses and load application software into the device.
The programming LED (10) goes out. The device is ready for operation.
- ⓘ If the programming LED (10) flashes slowly, it means that this is a new device which has not yet been programmed or that no compatible application has been loaded.

2.5 Programming LED

The programming LED of the weather station has four states. The fluorescent colour of the programming LED is blue.

What meaning do the states of the programming LED have?

Status	Meaning
Off	Application program is loaded. Device is ready for operation.
On	Programming mode is activated.
Slow flashing	The device has not loaded any compatible application. Device is not ready for operation.
Fast flashing	Firmware update. The firmware update may take some time.

3 Technical data

Supply

Rated voltage	AC 24 V SELV ($\pm 10\%$)
Rated voltage	DC 21 ... 32 V SELV
Current consumption	100 ... 400 mA (dependent on the weather)
Protection class	III

Connecting cable

Cable type	LiYCY 4xAWG26
Cable length	5 m

KNX

KNX medium	TP
Commissioning mode	S-mode
Rated voltage KNX	DC 21 ... 32 V SELV
Current consumption KNX	max. 5 mA

Ambient conditions

Ambient temperature	-30 ... +60 °C
Storage/transport temperature	-25 ... +70 °C
Degree of protection	IP 44 (in position for use)

Housing

Dimensions $\text{Ø} \times \text{H}$	130×68 mm
Weight	approx. 230 g

Wind speed sensor

Measuring range	approx. 0 ... 40 m/s
Resolution	0.1 m/s
Accuracy (≤ 10 m/s)	± 1 m/s
Accuracy (>10 m/s)	$\pm 5\%$

 Accuracy as RMS average value over 360°.

Wind direction sensor

Measuring range	1 ... 360°
Resolution	1°
Accuracy	$\pm 10^\circ$ (laminar wind stream)

Temperature sensor

Measuring range	-30 ... +60 °C
Resolution	0.1 K
Accuracy	± 1 K (Wind > 2 m/s, for -5 ... +25 °C)

Precipitation sensor

Measuring range	yes/no
Accuracy	Fine drizzle

Brightness sensors

Number	4
Measuring range	approx. 0 ... 150 klx
Spectral range	475 ... 650 nm
Resolution	1 klx
Accuracy	± 3 %

Twilight sensor

Measuring range	approx. 0 ... 900 lx
Resolution	1 lx
Accuracy	± 10 lx

Air pressure sensor

Measuring range	300 ... 1100 hPa
Resolution	0.01 hPa
Accuracy	± 0.5 hPa (20°C)

Air humidity sensor

Measuring range	0 ... 100 % rel. humidity
Resolution	0.1 % rel. humidity
Accuracy	± 10 % rel. humidity (20°C)
abs. humidity	0 ... 400 g/m ³
Resolution	0.01 g/m ³

Global radiation

Measuring range	0 ... 1300 Watt/m ²
Resolution	1 Watt/m ²
Accuracy	± 10 %
Spectral range	350 ... 1100 nm

i All accuracy specifications relate to the respective measuring range end value.

4 Software description

4.1 Software specification

ETS search paths: / Weatherstation KNX
 Configuration: S-mode standard
 PEI type: No PEI
 PEI connector: no connector

No.	Short description	Name	Version	from mask version
1	Application version for ETS 4 and ETS 5. ETS 5 or ETS 4.1.8 or more recent versions should be preferred for the commissioning of the weather station. Detection of the weather data wind speed and direction, precipitation, twilight, temperature and brightness in 4 directions. Evaluation of the data, in particular limiting value processing. The measured values for wind can be checked for plausibility, and the presence of the external power supply can be monitored. Disabling modules can be used to filter 1-bit, 8-bit or 16-bit values. Logic operations (AND, AND with return, OR, exclusive OR) with up to 4 inputs each are available. Optimised sensor evaluation.	KNX Weather station B00D	2.1 for ETS 4, preferably Version 4.1.8 or higher and ETS 5.	SystemB (07B0)

4.2 Software "KNX Weather station"

4.2.1 Scope of functions

- A temperature sensor determines the outdoor temperature of the location of the weather station. The measured value is output as a 16-bit value.
- A wind speed sensor (thermal) determines the wind speed currently prevailing at the mounting location of the weather station. The measured value is output as a 16-bit value. A sufficient distance from walls and obstacles must be maintained so that the wind is not blocked in any direction, and so that there are no eddies that could corrupt the measured values.
- The wind direction is determined using temperature measurement resistors and can be output via a 1-byte communication object.
- Four brightness sensors, set at 90° from each other, determine the brightness in specific directions during daylight and sunshine. The measured value is output as a 16-bit value. Thus, in a rectangular, three-sided conservatory, the light intensity on the three glazed surfaces can be determined. It must be ensured that there are no objects that could place the sensors in shade, unless they also shade the corresponding side of the building in the same way. At brightness values below 1000 Lux, the measured value is set to 0 Lux.
- The determined twilight value is output as a 16-bit value. At twilight values over 900 Lux, the measured value is limited to 900 Lux.
- A PIN photodiode measures the global radiation. This value allows the energy output to be determined over a specific period of time.
- A precipitation sensor makes a capacitive determination as to whether rain, snow or hail is falling at the weather station's location. The precipitation sensor's output is in the form of 1-bit values.
- The measurement of the relative air humidity is carried out using a measuring element. From this, in combination with the air temperature, the absolute humidity is calculated.
- A MEMS sensor measures the absolute air pressure. A comparison of multiple air pressure values can only be made with values previously calculated at a shared reference height.
- The mounting location of the weather station can be determined via GPS/GLONASS.
- Besides the calculated values "Maximum value of the brightness sensors" and "Absolute humidity", the weather station is able to calculate the "Felt temperature" and "Comfort".
- Two limiting values with hysteresis adjustable for each sensor can be configured internally or specified externally as 8-bit or 16-bit values. Because the precipitation sensor does not supply any analog signal, only limiting values for "rain ON" and "rain off" are available.
- The teaching function makes it possible to apply the current 2-byte measured value as a limiting value. This can be triggered by pressing an external pushbutton, for example.
- All the limiting value objects have a configurable switch-on delay and switch-off delay.
- 16 logic gates (AND, AND with feedback, OR, exclusive OR, NAND, NOR) with up to 4 inputs for external and internal 1-bit values.
- 4 disabling modules for disabling functions or manual operation
- Automatic shading control of up to 8 facades can be implemented with sun level-dependent tracking of the slats and blind/shutter height control.
- Output of all values can take place when values change and cyclically. The outputs of the disabling modules can only be sent when values change.
- Cascading of weather stations is possible using the logic functions. This is advisable for an expanded function (measurement of winds on various sides) or for greatly increased functional reliability through redundancy, for example in the case of very valuable outdoor blinds/shutters.

4.2.2 Data points

Number of communication objects: max. 267
 Number of addresses (max.): 400
 Number of assignments (max.): 400

Object table "Time"

Function: Reception of the time (GPS/GLONASS)

Object	Function	Name	Type	DPT	Flag
 15	GPS.Time	Measured value	3 bytes	10,001	C, T

Description 3-byte object for the output of the current time received via GPS or GLONASS. The object can only be sent cyclically. This communication object is only visible if the parameter "date/time" is set to "Internal clock".

Function: Reception of the date (GPS/GLONASS)

Object	Function	Name	Type	DPT	Flag
 16	GPS. Date	Measured value	3 bytes	11,001	C, T

Description 3-byte object for the output of the current date received via GPS or GLONASS. The object can only be sent cyclically. This communication object is only visible if the parameter "date/time" is set to "Internal clock".

Function: Detection of azimuth and elevation

Object	Function	Name	Type	DPT	Flag
 19, 20	Azimuth, elevation	Measured value	1 bytes	5,003	C, R, T

Description 1-byte objects for the output of the current sun position at the mounting location of the Weather station, if no GPS reception is possible at the mounting location and the "GPS/Glonass" parameter has been deactivated. The calculated angle of the azimuth and elevation are output via two communication objects. The date, time, position of the weather station and location height are important for the calculation of these two values. If one of these values is incorrect or unspecified, then the angle of the azimuth and the elevation are calculated incorrectly. These communication objects are then visible if the GPS/Glonass is deactivated and the parameter "Date/time" is set to "External clock".

Function: Detection of time change

Object	Function	Name	Type	DPT	Flag
 22	GPS.Time change	Measured value	1-bit	1,001	C, W

Description 1-bit object for time change. If a logical 1 is received, summer time is set. If a suitable transmitter writes a "0" to this object, the time changes to winter time. (Only visible when the automatic time change on the GPS/Glonass parameter page is set to "Via switching object".)

Function: GPS reception. Date/GPS. Time

Object	Function	Name	Type	DPT	Flag
 23	GPS.Send request date/time	Measured value	1-bit	1,001	C, W

Description 1-bit object for sending of a send request. Depending on the configuration, a logical "1" or a logical "0" casues a request to read the date and time values received via GPS/Glonass to be sent to the KNX. This communication object is only visible if the parameter "date/time" is set to "Internal clock".

Function: Reception of the time

Object	Function	Name	Type	DPT	Flag
 259	External date, time	Time. Input	3 bytes	10,001	C, W, T

Description 3-byte object for receiving the current time for the activation of the shading control. This communication object is only visible if the parameter "External specification, date and time" is set to Activated. This communication object is only visible if the parameter "date/time" is set to "External clock".

Function: Reception of the date

Object	Function	Name	Type	DPT	Flag
 260	External date, time	Date. Input	3 bytes	11,001	C, W, T

Description 3-byte object for receiving the current date for the activation of the shading control. This communication object is only visible if the parameter "External specification, date and time" is set to Activated. This communication object is only visible if the parameter "date/time" is set to "External clock".

Function: Date / time request

Object	Function	Name	Type	DPT	Flag
 261	External date, time	Request time / date	1-bit	1,003	C, T

Description 1-bit object to enable the automatic request of date and time by the Weather station. This communication object is only visible if the parameter "date/time" is set to "External clock".

4.2.2.1 Object table "Disabling modules"

Function: Binary external inputs of the disabling modules

Object	Function	Name	Type	DPT	Flag
 94, 97, 100, 103	Disabling module 1 - 4	Input switching	1-bit	1,001	C, W

Description 1 bit input switching objects of the disabling modules. Depending on the disabling object, the disabling modules switch the value of the input object to the output object. The object is only available in conjunction with output switching.

Function: External 1 byte inputs of the disabling modules

Object	Function	Name	Type	DPT	Flag
 94, 97, 100, 103	Disabling module 1 - 4	Input value 1 byte	1 bytes	5,001	C, W

Description 1 byte input objects of the disabling modules. Depending on the disabling object, the disabling modules switch the value of the input object to the output object. The object is only available in conjunction with a 1-byte output value.

Function: External 2 byte inputs of the disabling modules

Object	Function	Name	Type	DPT	Flag
 94, 97, 100, 103	Disabling module 1 - 4	Input value 2 byte	2 bytes	9.0xx	C, W

Description 2 byte input objects of the disabling modules. Depending on the disabling object, the disabling modules switch the value of the input object to the output object. The object is only available in conjunction with a 2-byte output value.

Function: Binary outputs of the disabling modules

Object	Function	Name	Type	DPT	Flag
 95, 98, 101, 104	Disabling module 1 - 4	Output switching	1-bit	1,001	C, T (R) ¹

Description 1 bit output switching objects of the disabling modules. Depending on the disabling object, the disabling modules switch the value of the input objects (depending on the parametrization, this can be an external or internal object, e.g. a limiting value) to the output object. The object is only available in conjunction with input switching.

1: Each communication object can be read out. For reading, the R-flag must be set.

Function: 1 byte outputs of the disabling modules

Object	Function	Name	Type	DPT	Flag
 95, 98, 101, 104	Disabling module 1 - 4	Output value 1 byte	1 bytes	5,001	C, T (R) ¹

Description 1 byte output objects of the disabling modules. Depending on the disabling object, the disabling modules switch the value of the external input object to the output object. No internal 1 byte values are present in this multiple sensor. The object is only available in conjunction with a 1-byte input value.

Function: 2 byte outputs of the disabling modules

Object	Function	Name	Type	DPT	Flag
 95, 98, 101, 104	Disabling module 1 - 4	Output value 2 byte	2 bytes	9.0xx	C, T (R) ¹

Description 2 byte output objects of the disabling modules. Depending on the disabling object, the disabling modules switch the value of the input objects to the output object. Depending on the configuration, this can be an external or internal object, (e.g. a measured value). The object is only available in conjunction with a 2-byte input value.

Function: Disabling the disabling modules

Object	Function	Name	Type	DPT	Flag
 96, 99, 102, 105	Disabling module 1 - 4	Disabling object	1-bit	1,001	C, W

Description Depending on these 1-bit input objects, the disabling modules will switch the input value through to the output. The disabling module can disable the disabling object with a 0 telegram or a 1 telegram. It is possible to parametrize the disabling response when the Multisensor is initialized.

1: Each communication object can be read out. For reading, the R-flag must be set.

4.2.2.2 Object table "Logic gates"

Function: External inputs of the logic gates						
Object	Function	Name	Type	DPT	Flag	
 106, 111, 116, 121, 126, 131, 136, 141, 146, 151, 156, 161, 166, 171, 176, 181	Logic gate 1 - 16	Input 1	1-bit	1,001	C, W	
Description 1-bit objects for activation of the logical inputs of the logic gates. Depending on the parameterisation, the inputs can be linked normally inverted 'AND', 'OR', 'exclusive OR' as well as 'AND with return'. Only visible when 'Input <i>n</i> ' is set to 'External input value'.						

Function: External inputs of the logic gates						
Object	Function	Name	Type	DPT	Flag	
 107, 112, 117, 122, 127, 132, 137, 142, 147, 152, 157, 162, 167, 172, 177, 182	Logic gate 1 - 16	Input 2	1-bit	1,001	C, W	
Description 1-bit objects for activation of the logical inputs of the logic gates. Depending on the parameterisation, the inputs can be linked normally inverted 'AND', 'OR', 'exclusive OR' as well as 'AND with return'. Only visible when 'Input <i>n</i> ' is set to 'External input value'.						

Function: External inputs of the logic gates

Object	Function	Name	Type	DPT	Flag
<input type="checkbox"/> ← 108, 113, 118, 123, 128, 133, 138, 143, 148, 153, 158, 163, 168, 173, 178, 183	Logic gate 1 - 16	Input 3	1-bit	1,001	C, W

Description 1-bit objects for activation of the logical inputs of the logic gates. Depending on the parameterisation, the inputs can be linked normally inverted 'AND', 'OR', 'exclusive OR' as well as 'AND with return'. Only visible when 'Input n' is set to 'External input value'.

Function: External inputs of the logic gates

Object	Function	Name	Type	DPT	Flag
<input type="checkbox"/> ← 109, 114, 119, 124, 129, 134, 139, 144, 149, 154, 159, 164, 169, 174, 179, 184	Logic gate 1 - 16	Input 4	1-bit	1,001	C, W

Description 1-bit objects for activation of the logical inputs of the logic gates. Depending on the parameterisation, the inputs can be linked normally inverted 'AND', 'OR', 'exclusive OR' as well as 'AND with return'. Only visible when 'Input n' is set to 'External input value'.

Function: Outputs of the logic gates

Object	Function	Name	Type	DPT	Flag
<input type="checkbox"/> ← 110, 115, 120, 125, 130, 135, 140, 145, 150, 155, 160, 165, 170, 175, 180, 185	Logic gate 1 - 16	Output	1-bit	1,001	C, T (R) ¹

Description 1 bit output objects of the logic gates. The result of the logic operation can be output normally or inverted. A switch-on and switch-off delay, sending after each input event or after each status change of the output as well as cyclical sending can be configured.

1: Each communication object can be read out. For reading, the R-flag must be set.

4.2.2.3 Object table "Shading control"

Function:	Shading control				
Object	Function	Name	Type	DPT	Flag
 202	Shading control	External basic brightness	1 bytes	5,001	C, W
Description	This communication object becomes visible if the parameter "Basic brightness threshold" is set to "External". The Weather station uses the object to receive the threshold value for the 1-byte shading control.				

Function:	Shading control (1-bit)				
Object	Function	Name	Type	DPT	Flag
 203, 210, 217, 224, 231, 238, 245, 252	Shading control	Shading facade 1 - 8	1-bit	1,001	C, T
Description	1-bit object per facade to activate, for example, a step-move object of a Venetian blind actuator. This communication object is only visible if the parameter "format of the shading objects" is set to "1-bit".				

Function:	Shading control (1-byte)				
Object	Function	Name	Type	DPT	Flag
 203, 210, 217, 224, 231, 238, 245, 252	Shading control	Shading facade 1 - 8	1 bytes	5,001	C, T
Description	1-byte object per facade to activate, for example, a positioning object of a Venetian blind actuator. This communication object is only visible if the parameter "format of the shading objects" is set to "1-byte (position)".				

Function:	Shading control				
Object	Function	Name	Type	DPT	Flag
 204, 211, 218, 225, 232, 239, 246, 253	Individual control	Opening angle, facade 1 - 8	1 bytes	5,003	C, W
Description	The opening angle determines in which area the sun azimuth must be located for an interfering glare to occur. This value can be specified in the parameters and also adjusted during operation using this 1-byte object for each facade.				

Function: Shading control (1-byte)

Object	Function	Name	Type	DPT	Flag
 205, 212, 219, 226, 233, 240, 247, 254	Individual control	Blind/shutter height, facade 1 - 8 position	1 bytes	5,001	C, T

Description 1-byte object per facade, which sends the position of the blind/shutter height to the KNX. The position of the blind/shutter height is sent after a blind/shutter height change. Depending on the configuration on the "facade *n*" parameter page, the device sends the position specification "at the beginning" or "at the end of the disabling function". This communication object is only visible if the parameter "Type of blind/shutter object " is set to "1-byte (position)".

Function: Shading control (1-bit)

Object	Function	Name	Type	DPT	Flag
 205, 212, 219, 226, 233, 240, 247, 254	Individual control	Blind/shutter height, facade 1 - 8, threshold 1	1-bit	1,001	C, T

Description 1-bit object per facade, which sends a "1" to the KNX each time threshold 1 is exceeded.
This communication object is only visible if:
"Type of blind/shutter object" = "1 bit" and
"Activate threshold 1" = "Yes"

Function: Shading control (1-bit)

Object	Function	Name	Type	DPT	Flag
 206, 213, 220, 227, 234, 241, 248, 255	Individual control	Blind/shutter height, facade 1 - 8, threshold 2	1-bit	1,001	C, T

Description 1-bit object per facade, which sends a "2" to the KNX each time threshold 1 is exceeded.
This communication object is only visible if:
"Type of blind/shutter object" = "1 bit" and
"Activate threshold 2" = "Yes"

Function: Shading control (1-bit)

Object	Function	Name	Type	DPT	Flag
 207, 214, 221, 228, 235, 242, 249, 256	Individual control	Blind/shutter height, facade 1 - 8, threshold 3	1-bit	1,001	C, T

Description 1-bit object per facade, which sends a "1" to the KNX each time threshold 3 is exceeded.
 This communication object is only visible if:
 "Type of blind/shutter object" = "1 bit" and
 "Activate threshold 3" = "Yes"

Function: Shading control

Object	Function	Name	Type	DPT	Flag
 208, 215, 222, 229, 236, 243, 250, 257	Individual control	Slat position, facade 1 - 8	1 bytes	5,001	C, T

Description 1-byte object per facade for the output of the current slat position to the KNX.

Function: Shading control

Object	Function	Name	Type	DPT	Flag
 209, 216, 223, 230, 237, 244, 251, 258	Shading control	Disable facade 1-8	1-bit	1,001	C, W

Description This object is used to disable individual facades.

4.2.2.4 Object table "Brightness sensor"

Function:	Brightness measurement				
Object	Function	Name	Type	DPT	Flag
 5, 6, 7, 8, 24	Brightness sensor 1, brightness sensor 2, brightness sensor 3, brightness sensor 4, Max. brightness sensors 1 to 4	Measured value for brightness	2 bytes	9,004	C, R, T
Description	2 byte objects for outputting the current measured values of the brightness sensors. The individual sensors are directional. They can be sent if there is a difference between the measured values and/or cyclically.				

Function:	Brightness measurement				
Object	Function	Name	Type	DPT	Flag
 25	Max. brightness and twilight	Measured value for brightness and twilight	2 bytes	9,004	C, R, T
Description	2 byte objects for outputting the current maximum value of the brightness sensors. If this value is lower than 1000 Lux, then the current value of the twilight sensor is output. The object can be transmitted if there is a difference between the measured values and/or cyclically.				

4.2.2.5 Object table "Twilight sensor"

Function: Twilight measurement

Object	Function	Name	Type	DPT	Flag
 ⁹	Twilight	Measured value for twilight	2 bytes	9,004	C, R, T

Description 2-byte object for outputting the current measured value of the twilight sensor. The individual sensors are directional. They can be sent if there is a difference between the measured values and/or cyclically.

4.2.2.6 Object table "Wind speed"

Function: Measurement of the wind speed in m/s

Object	Function	Name	Type	DPT	Flag
 ¹	Wind	Measured value wind speed[m/s]	2 bytes	9,005	C, R, T

Description 2 byte object for outputting the current measured value of the wind speed sensor. The object can be transmitted if there is a difference between the measured values and/or cyclically.

4.2.2.7 Object table "Wind direction"

Function:	Measurement of the wind direction				
Object	Function	Name	Type	DPT	Flag
 ²	Wind	Measured value, wind direction [0...360°]	1 bytes	5,003	C, R, T
Description	1-byte object for the output of the current wind direction. A northerly wind is output with 0°. The object can be transmitted if there is a difference between the measured values and/or cyclically. At a wind speed of 0 m/s, no wind direction can be determined and the output value of the communication object is set to 0°.				

Function:	Measurement of the wind orientation				
Object	Function	Name	Type	DPT	Flag
 ³	Wind	Measured value, wind orientation	14 bytes	16,000	C, R, T
Description	14-byte object for the output of the current wind orientation. Here, a text can be output for each compass direction, which is then output for the appropriate wind direction via the object, e.g. for indication via a display. The text may be a maximum of 14 characters in length.				

Function:	Output of the wind area signal				
Object	Function	Name	Type	DPT	Flag
 ⁴	Wind	Measured value, wind area signal	1-bit	1,001	C, R, T
Description	This 1-bit object for the output of the wind area signal is enabled if the "wind direction" parameter on the "General" parameter page is active. The limiting values 1 and 2 on the "wind area signal" parameter page define a wind area in °. This wind area in ° indicates the direction that the wind must flow from so that the device outputs a wind area signal to the KNX. If the wind direction between the defined limits is present, then a logical 1 is sent to the KNX. If the wind is in a different compass direction area outside the defined limits, then a "0" is sent to the KNX.				

4.2.2.8 Object table "Precipitation"

The "precipitation - limiting value 1" and "precipitation - limiting value 2" communication objects are only visible if the "Limiting values" parameter is set to "Limiting value 1 and 2 activated". Both communication objects are described in the "Limiting values" parameter group.

4.2.2.9 Object table "Absolute humidity"

Function:	Output of the absolute humidity				
Object	Function	Name	Type	DPT	Flag
 ²⁶	Absolute humidity	Measured value absolute humidity	2 bytes	7,001	C, R, T
Description	This object sends the calculated absolute humidity value to the KNX bus. The "DPT of measured value" parameter defines the format that the value is output in. (Only visible if the sensor is activated)				

Function:	Output of the absolute humidity				
Object	Function	Name	Type	DPT	Flag
 ²⁶	Absolute humidity	Measured value, absolute humidity	2 bytes	9,029	C, R, T
Description	This object sends the calculated absolute humidity value to the KNX bus. The "DPT of measured value" parameter defines the format that the value is output in. (Only visible if the sensor is activated)				

4.2.2.10 Object table "Relative humidity"

Function: Humidity measurement

Object	Function	Name	Type	DPT	Flag
 ¹³	Relative humidity	Measured value, relative humidity	2 bytes	9,007	C, R, T

Description 2 byte object for outputting the current measured value of the relative humidity. The object can be transmitted if there is a difference between the measured values and/or cyclically. (Only visible if the sensor is activated)

4.2.2.11 Object table "Temperature sensor"

Function: Temperature measurement

Object	Function	Name	Type	DPT	Flag
 ¹²	Temperature	Measured value for temperature	2 bytes	9,001	C, R, T

Description 2 byte object for outputting the current measured value of the temperature sensor. The object can be transmitted if there is a difference between the measured values and/or cyclically. (Only visible if the sensor is activated)

4.2.2.12 Object table "Felt temperature"

Function: Output of the felt temperature

Object	Function	Name	Type	DPT	Flag
 27	Felt temperature	Measured value felt temperature	2 bytes	9,001	C, R, T

Description This 2-byte object sends the calculated felt temperature value to the KNX bus.
(Only visible if the sensor is activated)
Due to the internal calculation, the felt temperature is output to the KNX with a time delay.

4.2.2.13 Object table "Comfort"

Function:	Output of oppressiveness				
Object	Function	Name	Type	DPT	Flag
 ²⁸	Oppressiveness	Measured value, oppressiveness	1-bit	1,001	C, R, T
Description	This 1-bit object sends the calculated oppressiveness value to the KNX bus. (Only visible if the sensor is activated)				

Function:	Output of comfort				
Object	Function	Name	Type	DPT	Flag
 ²⁹	Comfort	Measured value, comfort	1-bit	1,001	C, R, T
Description	This 1-bit object sends the calculated comfort value to the KNX bus. (Only visible if the sensor is activated)				

4.2.2.14 Object table "Air pressure"

Function: Measurement of the air pressure

Object	Function	Name	Type	DPT	Flag
 ¹⁴	Air pressure	Measured value, air pressure	2 bytes	9,006	C, R, T

Description 2-byte object for outputting the current measured value of the air pressure. The object can be transmitted if there is a difference between the measured values and/or cyclically. (Only visible if the sensor is activated)

4.2.2.15 Object table "Global radiation"

Function:	Measurement of the global radiation				
Object	Function	Name	Type	DPT	Flag
 ¹⁰	Global radiation	Measured value, global radiation	2 bytes	9,022	C, R, T
Description	2-byte object for outputting the current measured value of the global radiation. The output of the measured value via the communication object takes place in the unit W/m ² .				

4.2.2.16 Object table "GPS/Glonass"

Function: Reception of the geographic position (GPS/GLONASS)

Object	Function	Name	Type	DPT	Flag
 17, 18	GPS.Geographic longitude, GPS.Geographic latitude	Measured value	4 bytes	14,007	C, R

Description: 4-byte objects for the output of the current geographic position of the mounting location of the weather station. The geographic longitude and latitude are output via two communication objects. (Only visible if the sensor is activated)

Function: Detection of azimuth and elevation

Object	Function	Name	Type	DPT	Flag
 19, 20	GPS.Azimuth, GPS.Elevation	Measured value	1 bytes	5,003	C, R, T

Description: 1-byte objects for the output of the current sun position at the mounting location of the weather station. The angle of the azimuth and elevation are output via two communication objects. (Only visible if GPS/Glonass is activated)

Function: Detection of location height

Object	Function	Name	Type	DPT	Flag
 21	GPS.Location height	Measured value	4 bytes	14,039	C, R

Description: 4-byte objects for the output of the current location height of the mounting location of the weather station. The location height is output in metres via the communication object. (Only visible if the sensor is activated)

4.2.2.17 Object table "Monitoring"

Function:	Checking the wind signal for a defect				
Object	Function	Name	Type	DPT	Flag
 ²⁶²	Monitoring	Wind sensor unchanged	1-bit	1,001	C, T (R) ¹
Description	1 bit output object for checking the wind sensor for malfunctions. If a constant signal is measured for longer than the configurable time for 'Wind speed unchanged in minutes', then it is assumed that there is a defect in the wind sensor. This object can be used to move outdoor equipment that is vulnerable to winds, such as awnings or outdoor shutters, to a safe position and to report the suspected defect.				

Function:	Checking the wind signal for a defect				
Object	Function	Name	Type	DPT	Flag
 ²⁶³	Monitoring	Wind direction unchanged	1-bit	1,001	C, T (R) ¹
Description	1 bit output object for checking the wind sensor for malfunctions. If a constant signal is measured for longer than the configurable time for 'Wind direction unchanged in minutes', then it is assumed that there is a defect in the wind sensor. This object can be used to move outdoor equipment that is vulnerable to winds, such as awnings or outdoor shutters, to a safe position and to report the suspected defect.				

Function:	Checking the wind signal for a defect				
Object	Function	Name	Type	DPT	Flag
 ²⁶⁴	Monitoring	no wind signal	1-bit	1,001	C, T (R) ¹
Description	1 bit output object for checking the wind sensor for malfunctions. If a signal of 0 m/s is measured for longer than the parameterisable time for 'no wind in hours', then it is assumed that there is a defect in the wind sensor. This object can be used to move outdoor equipment that is vulnerable to winds, such as awnings or outdoor shutters, to a safe position and to report the suspected defect.				

Function:	Checking of the external voltage 24 V voltage supply				
Object	Function	Name	Type	DPT	Flag
 ²⁶⁵	Monitoring	Power supply ok	1-bit	1,001	C, T (R) ¹
Description	1-bit output object for checking whether the correct external supply voltage is present to supply power to the weather station. Operation of the of weather station is only possible when the correct supply voltage is present. This object can be used to move outdoor equipment that is vulnerable to precipitation, for example awnings, to a protected position and to report the suspected defect.				

1: Each communication object can be read out. For reading, the R-flag must be set.

Function: GPS error message

Object	Function	Name	Type	DPT	Flag
 266	Monitoring	Error message	1 bytes	5,010	C, T (R) ¹

Description 1-byte output object to output an error message of the GPS. Bits 2 to 7 are unused memory units and always have the logical state "1". If the weather station receives valid GPS values, a "0" is output for Bit 0 and Bit 1. As soon as Bit 0 or Bit 1 is sent to the KNX with a logical "1", then the appropriate value is invalid.

The following GPS/Glonass error messages can be output:

Bit 0: Invalid GPS/Glonass data,
Bit 1: Time of GPS converter is invalid

Sample messages:

252 = Valid GPS/Glonass data / Valid time of GPS converter

253 = Invalid GPS/Glonass data / Valid time of GPS converter

An application-orientated filter of the displayed messages can be performed by appropriate KNX devices or visualisation solutions.

Function: Sensor status

Object	Function	Name	Type	DPT	Flag
 267	Monitoring	Sensor status	2 bytes	7,001	C, T (R) ¹

Description The following sensor states are signalled to the KNX using this 2-byte output object with a logical "1" when the object is active:

Bit 0: Dew protection active,
Bit 1: Drying phase of the sensor surface,
Bit 2: Values of digital-analogue converter invalid,
Bit 3: Measured value of pressure sensor invalid,
Bit 4: Measured value of brightness sensor north invalid,
Bit 5: Measured value of brightness sensor east invalid,
Bit 6: Measured value of brightness sensor south invalid,
Bit 7: Measured value of brightness sensor west invalid,
Bit 8: Measured value for twilight invalid,
Bit 9: Measured value of global radiation sensor invalid,
Bit 10: Measured value of air temperature sensor invalid,
Bit 11: Measured value of precipitation sensor invalid,
Bit 12: Measured value of wind speed sensor invalid,
Bit 13: Measured value of wind direction sensor invalid,
Bit 14: Measured value for humidity measurement invalid,
Bit 15: Internal system error (Error bit 15 is reset every 20 seconds during initialisation of the device interface. A reason for a continuing error message could be that the external 24 V voltage power supply has been interrupted.)

Sample messages:

257 = Dew protection active / Measured value for twilight invalid

12288 = Measured value of wind speed sensor invalid / Measured value of wind direction sensor invalid

An application-orientated filter of the displayed messages can be performed by appropriate KNX devices or visualisation solutions.

1: Each communication object can be read out. For reading, the R-flag must be set.

4.2.2.18 Object table "Limiting value"

Function:		Output for limiting value 1				
Object	Function	Name	Type	DPT	Flag	
 30, 31, 32, ... 44, 45	Wind speed, Brightness sensor 1, Brightness sensor 2, Brightness sensor 3, Brightness sensor 4, Twilight, Global radiation, Precipitation, Temperature, Relative humidity, Air pressure, Max. brightness sensor 1 to 4, Max. brightness and twilight Absolute humidity, Felt temperature	Limiting value 1	1-bit	1,001	C, T (R) ¹	
Description	1 bit objects for outputting the current limiting value states. The object can be transmitted if there is a change in value and/or cyclically. Switch-on and switch-off delay is parameterizable.					

Function:		Output for limiting value 2				
Object	Function	Name	Type	DPT	Flag	
 46, 47, 48, ... 60, 61	Wind speed, Brightness sensor 1, Brightness sensor 2, Brightness sensor 3, Brightness sensor 4, Twilight, Global radiation, Precipitation, Temperature, Relative humidity, Air pressure, Max. brightness sensor 1 to 4, Max. brightness and twilight Absolute humidity, Felt temperature	Limiting value 2	1-bit	1,001	C, T (R) ¹	
Description	1 bit objects for outputting the current limiting value states. The object can be transmitted if there is a change in value and/or cyclically. Switch-on and switch-off delay is parameterizable.					

1: Each communication object can be read out. For reading, the R-flag must be set.

4.2.2.19 Object table "External limiting values"

Function: Value specification for wind speed limiting value 1 via external devices

Object	Function	Name	Type	DPT	Flag
 62	Wind speed	External limiting value 1	2 bytes	9,005	C, W

Description 2-byte objects for specifying the limiting value for wind speed via external value transmitters.

Function: Specification of wind limiting value 1 in percent of upper range value via external devices

Object	Function	Name	Type	DPT	Flag
 62	Wind speed	External limiting value 1 [%]	1 bytes	5,001	C, W

Description 1-byte objects for specifying the limiting value for wind in percent via external value transmitters. The wind speed can be specified.

Function: Specification of wind limiting value 1 by means of teaching function

Object	Function	Name	Type	DPT	Flag
 62	Wind speed	External limiting value 1 (teaching)	1-bit	1,001	C, W

Description A change of state of the 1-bit switching object from '0' to '1', triggered, for example, via an external push-button, causes the current measured value of the sensor to be saved as the new limiting value.

Function: Value specification for wind direction limiting value 1 via external devices

Object	Function	Name	Type	DPT	Flag
 63	Wind direction	External limiting value 1	2 bytes	9.xxx	C, W

Description 2 byte objects for specifying the limiting value of the wind direction via external value transmitters.

Function: Specification of wind limiting value 1 in percent of upper range value via external devices

Object	Function	Name	Type	DPT	Flag
 63	Wind direction	External limiting value 1 [%]	1 bytes	5,001	C, W

Description 1-byte objects for specifying the limiting value for wind in percent via external value transmitters. The wind direction can be specified.

Function: Specification of wind limiting value 1 in percent via external devices

Object	Function	Name	Type	DPT	Flag
 63	Wind direction	External limiting value 1 [%]	1 bytes	5,003	C, W

Description 1 byte objects for specifying the limiting value of the wind direction in degrees via external value transmitters. The wind direction can be specified.

Function: Value specification for brightness and twilight limiting values 1 via external devices

Object	Function	Name	Type	DPT	Flag
 64, 65, 66, 67, 68, 74, 75	Brightness sensor 1, brightness sensor 2, brightness sensor 3, brightness sensor 4, Twilight, Max. brightness sensor 1 to 4, Max. brightness 1 to 4 and Twilight	External limiting value 1	2 bytes	9,004	C, W

Description 2 byte objects for specifying the limiting values for brightness and twilight via an external value transmitter.

Function: Specification of brightness and twilight limiting values 1 in percent of the upper range value via external devices

Object	Function	Name	Type	DPT	Flag
 64, 65, 66, 67, 68, 74, 75	Brightness sensor 1, brightness sensor 2, brightness sensor 3, brightness sensor 4, Twilight, Max. brightness sensor 1 to 4, Max. brightness 1 to 4 and Twilight	External limiting value 1 [%]	1 bytes	5,001	C, W

Description 1 byte objects for specifying the limiting values for brightness and/or twilight in percent, relative to the measuring range upper range value of the sensor (110 klx or 674 lux), via an external value transmitter.

Function: Specification of brightness and twilight limiting values 1 by means of teaching function

Object	Function	Name	Type	DPT	Flag
 64, 65, 66, 67, 68, 74, 75	Brightness sensor 1, brightness sensor 2, brightness sensor 3, brightness sensor 4, Twilight, Max. brightness sensor 1 to 4, Max. brightness 1 to 4 and Twilight	External limiting value 1 (teaching)	1-bit	1,001	C, W

Description A change of state of the 1-bit switching objects from '0' to '1', triggered, for example, via an external push-button, causes the current measured value of the sensor to be saved as the new limiting value.

Function: Value specification for global radiation limiting value 1 via external devices

Object	Function	Name	Type	DPT	Flag
 69	Global radiation	External limiting value 1	2 bytes	9,022	C, W

Description 2-byte objects for specifying the limiting value for global radiation via external value transmitters.

Function: Specification of global radiation limiting value 1 in percent of upper range value via external devices

Object	Function	Name	Type	DPT	Flag
 69	Global radiation	External limiting value 1 [%]	1 bytes	5,001	C, W

Description 1-byte object for specifying the limiting value for global radiation in percent via external value transmitters.

Function: Value specification for temperature limiting value 1 via external devices

Object	Function	Name	Type	DPT	Flag
 71, 77	Temperature, Felt temperature	External limiting value 1	2 bytes	9,001	C, W

Description 2 byte objects for specifying the limiting value for temperature via external value transmitters.

Function: Specification of temperature limiting value 1 in percent of the upper range value via external devices

Object	Function	Name	Type	DPT	Flag
 71, 77	Temperature, Felt temperature	External limiting value 1 [%]	1 bytes	5,001	C, W

Description 1 byte object for specifying the limiting values for the temperature in percent, relative to the measuring range of the sensor (0%=-20°C, 50%=17.5°C, 100%=55°C), via external value transmitters.

Function: Specification of temperature limiting value 1 by means of teaching function

Object	Function	Name	Type	DPT	Flag
 71, 77	Temperature, Felt temperature	External limiting value 1 (teaching)	1-bit	1,001	C, W

Description A change of state of the 1-bit switching object from '0' to '1', triggered, for example, via an external push-button, causes the current measured value of the sensor to be saved as the new limiting value.

Function: Value specification for humidity limiting value 1 via external devices

Object	Function	Name	Type	DPT	Flag
 72	Relative humidity	External limiting value 1	2 bytes	9,007	C, W

Description 2-byte objects for specifying the limiting value for relative humidity.

Function: Value specification for humidity limiting value 1 in percent of upper range value via external devices

Object	Function	Name	Type	DPT	Flag
 72	Relative humidity	External limiting value 1 [%]	1 bytes	5,001	C, W

Description: 1-byte objects for specifying the limiting value for humidity in percent via external value transmitters. The relative humidity can be specified.

Function: Value specification for air pressure limiting value 1 via external devices

Object	Function	Name	Type	DPT	Flag
 73	Air pressure	External limiting value 1	2 bytes	9,006	C, W

Description: 2-byte objects for specifying the limiting value for air pressure via external value transmitters.

Function: Specification of air pressure limiting value 1 in percent of upper range value via external devices

Object	Function	Name	Type	DPT	Flag
 73	Air pressure	External limiting value 1 [%]	1 bytes	5,001	C, W

Description: 1-byte object for specifying the air pressure for global radiation in percent via external value transmitters.

Function: Specification of humidity limiting value 1 via external devices

Object	Function	Name	Type	DPT	Flag
 76	Absolute humidity	External limiting value 1	2 bytes	9,029	C, W

Description: 2-byte objects for specifying the limiting value for humidity via external value transmitters. The absolute humidity can be specified.

Function: Specification of humidity limiting value 1 in percent of upper range value via external devices

Object	Function	Name	Type	DPT	Flag
 76	Absolute humidity	External limiting value 1 [%]	1 bytes	5,001	C, W

Description: 1-byte objects for specifying the limiting value for humidity in percent via external value transmitters. The absolute humidity can be specified.

Function: Value specification for wind speed limiting value 2 via external devices

Object	Function	Name	Type	DPT	Flag
 ⁷⁸	Wind speed	External limiting value 2	2 bytes	9,005	C, W

Description 2-byte objects for specifying the limiting value for wind speed via external value transmitters.

Function: Specification of wind limiting value 2 in percent of upper range value via external devices

Object	Function	Name	Type	DPT	Flag
 ⁷⁸	Wind speed	External limiting value 2 [%]	1 bytes	5,001	C, W

Description 1-byte objects for specifying the limiting value for wind in percent via external value transmitters. The wind speed can be specified.

Function: Specification of wind limiting value 2 by means of teaching function

Object	Function	Name	Type	DPT	Flag
 ⁷⁸	Wind speed	External limiting value 2 (teaching)	1-bit	1,001	C, W

Description A change of state of the 1-bit switching object from '0' to '1', triggered, for example, via an external push-button, causes the current measured value of the sensor to be saved as the new limiting value.

Function: Value specification for wind direction limiting value 2 via external devices

Object	Function	Name	Type	DPT	Flag
 ⁷⁹	Wind direction	External limiting value 1	2 bytes	9.xxx	C, W

Description 2 byte objects for specifying the limiting value of the wind direction via external value transmitters.

Function: Specification of wind limiting value 2 in percent of upper range value via external devices

Object	Function	Name	Type	DPT	Flag
 ⁷⁹	Wind direction	External limiting value 2 [%]	1 bytes	5,001	C, W

Description 1-byte objects for specifying the limiting value for wind in percent via external value transmitters. The wind direction can be specified.

Function: Specification of wind limiting value 2 in percent via external devices

Object	Function	Name	Type	DPT	Flag
 79	Wind direction	External limiting value 2 [%]	1 bytes	5,003	C, W

Description 1 byte objects for specifying the limiting value of the wind direction in degrees via external value transmitters. The wind direction can be specified.

Function: Value specification for brightness and twilight limiting values 2 via external devices

Object	Function	Name	Type	DPT	Flag
 80, 81, 82, 83, 84, 90, 91	Brightness sensor 1, brightness sensor 2, brightness sensor 3, brightness sensor 4, Twilight, Max. brightness sensor 1 to 4, Max. brightness 1 to 4 and Twilight	External limiting value 2	2 bytes	9,004	C, W

Description 2 byte objects for specifying the limiting values for brightness and twilight via an external value transmitter.

Function: Specification of brightness and twilight limiting values 2 in percent of the upper range value via external devices

Object	Function	Name	Type	DPT	Flag
 80, 81, 82, 83, 84, 90, 91	Brightness sensor 1, brightness sensor 2, brightness sensor 3, brightness sensor 4, Twilight, Max. brightness sensor 1 to 4, Max. brightness 1 to 4 and Twilight	External limiting value 2 [%]	1 bytes	5,001	C, W

Description 1 byte objects for specifying the limiting values for brightness and/or twilight in percent, relative to the measuring range upper range value of the sensor (110 klx or 674 lux), via an external value transmitter.

Function: Specification of brightness and twilight limiting values 2 by means of teaching function

Object	Function	Name	Type	DPT	Flag
 80, 81, 82, 83, 84, 86, 90, 91	Brightness sensor 1, brightness sensor 2, brightness sensor 3, brightness sensor 4, Twilight, Precipitation, Max. brightness sensor 1 to 4, Max. brightness 1 to 4 and Twilight	External limiting value 2 (teaching)	1-bit	1,001	C, W

Description A change of state of the 1-bit switching objects from '0' to '1', triggered, for example, via an external push-button, causes the current measured value of the sensor to be saved as the new limiting value.

Function: Value specification for global radiation limiting value 2 via external devices

Object	Function	Name	Type	DPT	Flag
 85	Global radiation	External limiting value 2	2 bytes	9,022	C, W

Description 2-byte objects for specifying the limiting value for global radiation via external value transmitters.

Function: Specification of global radiation limiting value 2 in percent of upper range value via external devices

Object	Function	Name	Type	DPT	Flag
 85	Global radiation	External limiting value 2 [%]	1 bytes	5,001	C, W

Description 1-byte object for specifying the limiting value for global radiation in percent via external value transmitters.

Function: Value specification for temperature limiting value 2 via external devices

Object	Function	Name	Type	DPT	Flag
 87, 93	Temperature, Felt temperature	External limiting value 2	2 bytes	9,001	C, W

Description 2 byte objects for specifying the limiting value for temperature via external value transmitters.

Function: Specification of temperature limiting value 2 in percent of the upper range value via external devices

Object	Function	Name	Type	DPT	Flag
 87, 93	Temperature, Felt temperature	External limiting value 2 [%]	1 bytes	5,001	C, W

Description 1 byte object for specifying the limiting values for the temperature in percent, relative to the measuring range of the sensor (0%=-20°C, 50%=17.5°C, 100%=55°C), via external value transmitters.

Function: Specification of temperature limiting value 2 by means of teaching function

Object	Function	Name	Type	DPT	Flag
 87, 93	Temperature, Felt temperature	External limiting value 2 (teaching)	1-bit	1,001	C, W

Description A change of state of the 1-bit switching object from '0' to '1', triggered, for example, via an external push-button, causes the current measured value of the sensor to be saved as the new limiting value.

Function: Value specification for humidity limiting value 2 via external devices

Object	Function	Name	Type	DPT	Flag
 88	Relative humidity	External limiting value 2	2 bytes	9,007	C, W

Description 2-byte objects for specifying the limiting value for relative humidity.

Function: Specification of humidity limiting value 2 in percent of upper range value via external devices

Object	Function	Name	Type	DPT	Flag
 ⁸⁸	Relative humidity	External limiting value 2 [%]	1 bytes	5,001	C, W

Description: 1-byte objects for specifying the limiting value for humidity in percent via external value transmitters. The relative humidity can be specified.

Function: Value specification for air pressure limiting value 2 via external devices

Object	Function	Name	Type	DPT	Flag
 ⁸⁹	Air pressure	External limiting value 2	2 bytes	9,006	C, W

Description: 2-byte objects for specifying the limiting value for air pressure via external value transmitters.

Function: Specification of air pressure limiting value 2 in percent of upper range value via external devices

Object	Function	Name	Type	DPT	Flag
 ⁸⁹	Air pressure	External limiting value 2 [%]	1 bytes	5,001	C, W

Description: 1-byte object for specifying the air pressure for global radiation in percent via external value transmitters.

Function: Specification of humidity limiting value 2 via external devices

Object	Function	Name	Type	DPT	Flag
 ⁹²	Absolute humidity	External limiting value 2	2 bytes	9,029	C, W

Description: 2-byte objects for specifying the limiting value for humidity via external value transmitters. The absolute humidity can be specified.

Function: Specification of humidity limiting value 2 in percent of upper range value via external devices

Object	Function	Name	Type	DPT	Flag
 ⁹²	Absolute humidity	External limiting value 2 [%]	1 bytes	5,001	C, W

Description: 1-byte objects for specifying the limiting value for humidity in percent via external value transmitters. The absolute humidity can be specified.

4.2.3 Functional description

4.2.3.1 Application-oriented functional description

Protection outdoor equipment against the effects of weather

The weather station makes it possible to protect outdoor equipment and facade elements against damage from weather. In general, such outdoor equipment and facade elements, such as awnings and externally mounted shutters, are endangered by the following three weather effects:

- Danger from wind
- Danger from frost
- Danger from precipitation

Which of these weather effects endangers the outdoor equipment, and to what extent, depend on the facade elements themselves. Please consult the technical data and descriptions from the manufacturer in question.

- i** For a correct function, the weather station requires the external supply voltage. If the external supply voltage fails during operation, all measured value objects (e.g., "Wind speed", "Temperature") and the objects to be monitored "Wind sensor unchanged", "Wind direction unchanged" and "No wind signal" are not updated. If the external supply is not available or insufficient, this can optionally be reported to the bus via the object "Supply voltage ok".
- When measured values for safety-relevant applications are used, such as wind alarm for awning or blind, an OR link must be established with the object "Supply voltage ok". (see page 57-58).

Protection of outdoor systems against damage from frost

In order to protect awnings, outdoor shutters or other vulnerable blinds/shutters against icing, there are two factors that need to be taken into consideration.

Firstly, if the temperature drops below about 3°C, blinds/shutters that are in danger, such as awnings, should always be retracted.

If, even when the temperature is below 3°C, glare protection by outdoor Venetian blinds is still desired, then the precipitation should also be considered as a factor that may lead to icing. In this case, the Venetian blinds only move up if the temperature drops below 3°C and precipitation is falling. When the precipitation stops, the danger of icing remains until the temperature rises above the limiting value of approximately 3°C. Only then should the awning be extended again.

- i** For a correct function, the weather station requires the external supply voltage. If the external supply voltage fails during operation, all measured value objects (e.g., "Wind speed", "Temperature") and the objects to be monitored "Wind sensor unchanged", "Wind direction unchanged" and "No wind signal" are not updated. If the external supply is not available or insufficient, this can optionally be reported to the bus via the object "Supply voltage ok".
- When measured values for safety-relevant applications are used, such as wind alarm for awning or blind, an OR link must be established with the object "Supply voltage ok". (see page 57-58).

- i** Be sure here to observe the instructions from the manufacturer of the facade elements.

Parametrizing anti-icing protection depending to temperature and precipitation

To fulfil this task, two simple logic gates have to be combined. The first gate is used for activation and the second gate for deactivation of the anti-icing protection.

Activation of the anti-icing protection

The temperature and the precipitation sensor and at least two logic gates must be freely available in the device and activated.

Adjustments for the temperature sensor:

- Activate the temperature sensor on the "General" parameter page. The appropriate parameter page is enabled.
- Activate 'Limiting value n ' via the parameter "Limiting values" on the parameter page "Temperature sensor".
- On the parameter page "Temperature sensor limiting value n ", set
The parameter "Limiting value n in °C" to '3°C',
The parameter "Hysteresis limiting value n in °C" to '2 K' and
The parameter "Activation limiting value n " to "Undershoot LV = ON, exceed LV + hyst.=OFF".

Adjusting the precipitation sensor:

- Activate the precipitation sensor on the "General" parameter page. The appropriate parameter page is enabled.
- Activate 'Limiting value n ' via the parameter "Limiting values" on the parameter page "Precipitation"
- On the parameter page "Precipitation limiting value n ", set
The parameter "Limiting value n " to 'ON when raining',
The parameter "Switch-on delay limiting value n " to 'No delay' and
The parameter "Switch-off delay limiting value n " to, for example, '15 min delay'.

Settings of the logic gate:

- Enable at least one logic gate on the "General" parameter page. The appropriate parameter page is enabled.
- On the parameter page "Logic gate n ", set
The parameter "Type of logic operation" to 'AND',
The parameter "Send output at" to 'Every input event',
The parameter "Number of inputs" to '2',
The parameter "Output response" to 'Normal',
The parameter "Switch-on delay" to 'No delay',
The parameter "Switch-off delay" to 'No telegram' and
The parameter "Cyclical sending of the output" to, for example, '60'.
In the last setting, ensure that the actuator permits cyclical sending every 60 seconds without noise.

i If a jerking of the blinds can be heard with each telegram, then select '0' for do not send cyclically.

- On the parameter page "Logic gate n inputs", set
The parameter "Input n " to 'Internal input value',
The parameter "Response, input n " to 'Normal',
The parameter "Assign input n " to 'Temperature - LV n ',
The parameter "Input 2" to 'Internal input value',
The parameter "Response, input 2" to 'Normal' and
The parameter "Assign input 2" to 'Precipitation - LV n '.
- The logical output of the gate is connected to the safety object, e.g. of a Venetian blind actuator, via a group address in the ETS.
The activation of the anti-icing protection responds according to the following logic.

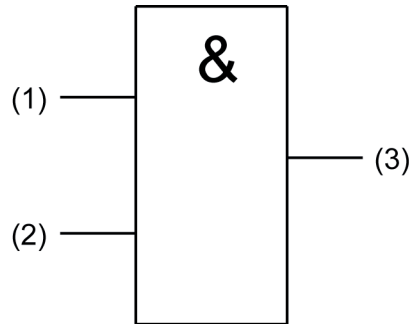

Figure 9: Activation of anti-icing protection

- (1) Limiting value n temperature
- (2) Limiting value n precipitation
- (3) Output logic gate n for activation of the anti-icing protection

i Only an ON telegram is sent. The OFF telegram is suppressed.

Deactivation of the anti-icing protection

Activation of the anti-icing protection must have been carried out as described above.

- Enable at least one logic gate on the "General" parameter page. The appropriate parameter page is enabled.
- On the parameter page "Logic gate n ", set
 - The parameter "Type of logic operation" to 'AND',
 - The parameter "Send output at" to 'Every input event',
 - The parameter "Number of inputs" to '1',
 - The parameter "Output response" to 'Normal',
 - The parameter "Switch-on delay" to 'No telegram',
 - The parameter "Switch-off delay" to 'No delay' and
 - The parameter "Cyclical sending of the output" to, for example, '60'.
 In the last setting, ensure that the actuator permits cyclical sending every 60 seconds without noise.

i If a jerking of the blinds can be heard with each telegram, then select '0' for do not send cyclically.

- On the parameter page "Logic gate n inputs", set
 - The parameter "Input n " to 'Internal input value',
 - The parameter "Response, input n " to 'Normal' and
 - The parameter "Assign input n " to 'Temperature - LV n '.
 - The logical output of the gate is connected to the safety object, e.g. of a Venetian blind actuator, via a group address in the ETS.
- The deactivation of the anti-icing protection responds according to the following logic.

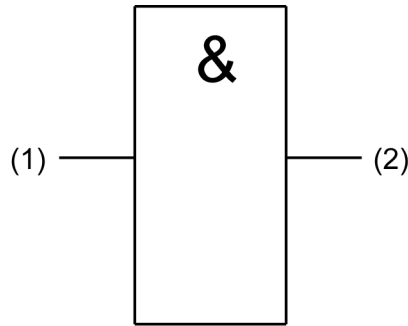

Figure 10: Deactivation of the anti-icing protection

- (1) Temperature limiting value n
- (2) Output logic gate n for deactivation of the anti-icing protection

i Only an OFF telegram is sent. The ON telegram is suppressed.

The following time diagram provides an explanation of the mode of operation.

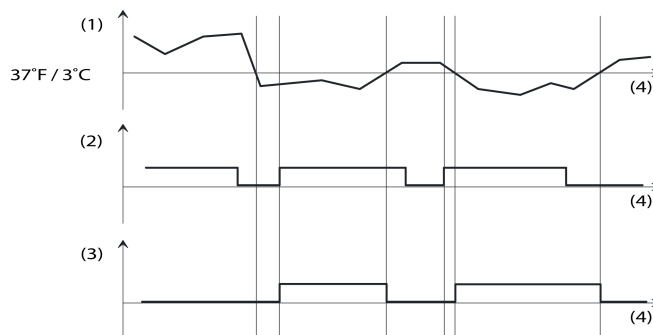

Figure 11: Anti-icing protection depending on temperature and precipitation

- (1) Measured temperature curve
- (2) Signal of the precipitation sensor
- (3) Both output signal for control of the actuator are connected with the safety input.
- (4) Time axis

Plausibility check of the measured values using the example of the wind measurement

Besides the output of pure measured values, such as wind speed and wind direction, the weather station also provides the option of checking the measured results for plausibility. To do this, set the times for 'No wind' and 'Wind speed unchanged' on the "Monitoring" parameter page in accordance with local conditions. Consult the local meteorological stations for the appropriate values.

For a plausibility check of the wind measurement, the set limiting value is linked with a logical OR to the monitoring functions 'No wind signal', 'Wind speed unchanged' and 'Power supply ok'. In order to further increase reliability in the event of incorrect measurements, the limiting value of an additional wind sensor can also be linked via an additional OR gate. This function is explained in the following function illustration.

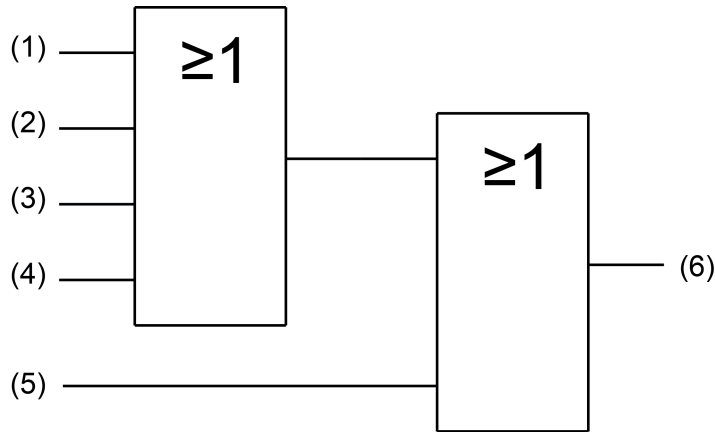

Figure 12: Gating of the signals

- (1) Wind speed GW1 or GW2
- (2) Monitoring 'No wind'
- (3) Monitoring 'Wind speed unchanged'
- (4) Monitoring 'Power supply ok'
- (5) If necessary limiting value of the external wind sensor
- (6) Output of the gate connected to the safety inputs of the outdoor system actuators via a group address.

- i** For a correct function, the weather station requires the external supply voltage. If the external supply voltage fails during operation, all measured value objects (e.g., "Wind speed", "Temperature") and the objects to be monitored "Wind sensor unchanged", "Wind direction unchanged" and "No wind signal" are not updated. If the external supply is not available or insufficient, this can optionally be reported to the bus via the object "Supply voltage ok".
When measured values for safety-relevant applications are used, such as wind alarm for awning or blind, an OR link must be established with the object "Supply voltage ok".

Protection of outdoor equipment against damage from wind.

For wind monitoring, the weather station is equipped with a wind sensor, which detects the wind speed thermally. Using two configurable limiting values, the outdoor systems can be moved to a position protected from the wind using an appropriate actuator input. In the case of large buildings or convoluted layouts, it may be advisable to combine a number of additional wind sensors and to link them as a logical OR via one of the 16 logic gates.

Besides simply measuring the wind speed, the weather station also provides the option of checking the measured results for plausibility.

- i** For a correct function, the weather station requires the external supply voltage. If the external supply voltage fails during operation, all measured value objects (e.g., "Wind speed", "Temperature") and the objects to be monitored "Wind sensor unchanged", "Wind direction unchanged" and "No wind signal" are not updated. If the external supply is not available or insufficient, this can optionally be reported to the bus via the object "Supply voltage ok".
When measured values for safety-relevant applications are used, such as wind alarm for awning or blind, an OR link must be established with the object "Supply voltage ok". (see page 57-58).

The wind speed is usually indicated in metres per second or in kilometres per hour. Since 1806 there has been a subdivision into speed levels developed by Sir Francis Beaufort. For this reason the unit for wind speed is named after him. The abbreviation for this is "bft". The following table provides an overview of the various wind speed levels, and is intended to make the configuration of appropriate values easier.

bft	m/s	km/h	Name	Description
0	0.0 ... 0.4	0.0 ... 1.8	Calm	No air movement. Smoke rises vertically.
1	0.5 ... 2.0	1.9 ... 7.3	Light air	Wind hardly noticeable, wind motion visible in smoke, no motion in wind vanes
2	2.1 ... 3.5	7.4 ... 12.9	Light breeze	Leaves rustle, wind felt on face
3	3.6 ... 5.6	13.0 ... 20.3	Gentle breeze	Leaves and smaller twigs in constant motion
4	5.7 ... 8.1	20.4 ... 29.5	Moderate breeze	'Small branches move, loose paper is picked up from the ground
5	8.2 ... 11.2	29.6 ... 40.6	Fresh breeze	Larger branches and trees in motion, wind clearly audible
6	11.3 ... 14.3	40.7 ... 51.8	Strong breeze	Large branches in motion. Whistling heard in overhead wires.
7	14.4 ... 17.4	51.9, ... 63.8	Near gale	Whole trees in motion. Effort needed to walk against the wind.
8	17.5 ... 21.0	63.9 ... 75.8	Gale	Large trees in motion, twigs broken from trees, very difficult to walk
9	21.1 ... 24.6	75.9 ... 88.8	Strong gale	Branches broken from trees, roof tiles torn from houses.
10	24.7 ... 28.7	88.9 ... 103.6	Storm	Trees uprooted, damage to houses
11	28.8 ... 32.8	103.7 ... 118.4	Violent storm	Powerful gusts, widespread structural damage
12	Over 32.8	Over 118.4	Hurricane	Considerable and widespread damage to structures

Assessment of wind speeds

Adjusting protection of outdoor equipment against damage from wind

Precondition: The "Wind speed" function and at least one of the 16 logic gates must be available and activated on the device.

Adjusting the wind sensor:

- Activate the wind speed on the "General" parameter page. The appropriate parameter page is enabled.
- Active 'Limiting value n ' via the "Limiting values" parameter on the "Wind speed" parameter page.
- On the "Wind speed limiting value n " parameter page is
 The parameter "Limiting value n in m/s" to 'x m/s',
 The parameter "Hysteresis limiting value n in m/s" to '5 m/s' and
 The parameter "Activation limiting value n " to 'Exceed LV=ON, Exceed. LV - hyst.=OFF'.

- i Refer to the manufacturer's data on the element to be protected for the value for wind speed 'x', at which a protected position is to be approached.

Settings of the monitoring function:

- Activate monitoring on the "General" parameter page. The appropriate parameter page is enabled.
- On the parameter page "Monitoring", set
The parameter "Monitor wind signal" to 'Monitor',
the parameter "Max. time for 'No wind in hours", for example, to '10' and
the parameter "Max. time for 'wind speed unchanged' in minutes" to a value suitable for the mounting location, e.g. '10'.

- i For the matching times, please consult the meteorological station responsible for the location.

- i The monitoring bits are sent with every change of state independently of the setting 'Cycl. sending of the monitoring bits'. The internal evaluation follows immediately after the object value. This means that the value is also evaluated internally on each send command.

Settings of the logic gate:

- Enable at least one logic gate on the "General" parameter page. The appropriate parameter page is enabled.
- On the parameter page "Logic gate *n*", set
The parameter "Type of logic operation" to 'OR',
The parameter "Send output at" to 'Every input event',
The parameter "Number of inputs" to '3 inputs',
The parameter "Output response" to 'Normal',
The parameter "Switch-on delay" to 'No delay',
The parameter "Switch-off delay" to 'No delay' and
The parameter "Cyclical sending of the output" to, for example, '30'.
In the last setting, ensure that the actuator permits cyclical sending every 60 seconds without noise.

- i If a noise can frequently be heard from the Venetian blinds without any position change, then apply "Transmit output on 'Change of output'".

- On the parameter page "Logic gate *n* inputs", set
The parameter "Input 1" to 'Internal input value',
the parameter "Assign input 1" to 'Wind speed - LV*n*' and
the parameter "Response, input 1" to 'normal'.
- On the parameter page "Logic gate *n* inputs", set
The parameter "Input 2" to 'Internal input value',
the parameter "Assign input 2" to 'Monitoring wind speed' and
the parameter "Response, input 2" to 'normal'.
- On the parameter page "Logic gate *n* inputs", set
The parameter "Input 3" to 'Internal input value',
the parameter "Assign input 3" to 'Monitoring no wind signal' and
The parameter "Response, input 3" to 'Normal' and
adjust
- The logical output of the gate is connected to the safety object, e.g. of a Venetian blind actuator, via a group address in the ETS.
The control of the wind alarm responds according to the following logic.

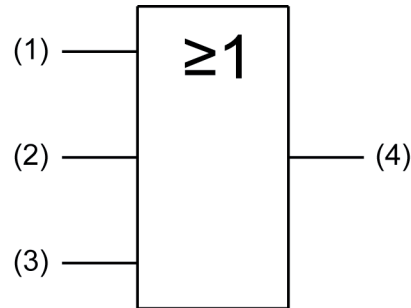

Figure 13: Logic for controlling the wind alarm

- (1) Wind speed limiting value n
- (2) Monitoring wind speed
- (3) Monitoring no wind signal
- (4) Output logic gate n

i For increased safety, the limiting value of an additional wind sensor can be integrated via an additional input.

Protecting outdoor equipment against damage from water

To detect rain, snow and sleet, the weather station is equipped with a capacitive precipitation sensor. In contrast to the other weather sensors, the precipitation sensor does not output any analogue measured values, but rather sends a switching telegram with a settable value as soon as precipitation is detected.

i For a correct function, the weather station requires the external supply voltage. If the external supply is not available or insufficient, the device reports "Precipitation" to the bus. If the external supply voltage fails during operation, the KNX telegram will be sent twice.

4.2.3.2 Disabling modules

In order to be able to suppress the automatic control of functions by measured values, limiting values or other outputs of the weather station, four disabling modules are integrated into the software. These disabling modules consist of an input object, an output object and a disabling object. They function like a gate that is either open or closed. Depending on the value of the disabling object, the value of the input object is either forwarded unchanged to the output object (gate open), or the channel is closed (gate closed). If, during disabling, the input value is changed, then the output sends this value as soon as the block is lifted.

The disabling object itself is a 1-bit communication object, whose behaviour (disable on 0, disable on 1) and the status can be set on initialisation.

Parametrising disabling modules

The following settings must be made in order to use a disabling module.

- On the "General" parameter page, the required number of "disabling modules" (max. four) should be enabled.
- On the parameter page "Disabling module *n*", set the parameter "Disabling response on initialisation" to 'Disable on 1 telegram' or 'Disable on 0 telegram'.
- On the parameter page "Disabling module *n*", configure the parameter "Type input/output" to 'Switching 1-bit', 'Value 2-byte' or 'Rel. value 1-byte'.
- The "Input" parameter defines whether an internal or an external input value should be assigned.
- If an 'Internal input value' was selected for the appropriate input, the parameter "Assign input" selects the desired input. The list of available values changes dynamically with the selection of the parameter 'Type input/output'. No internal relative values are present in the weather station.

The disabling module is set.

4.2.3.3 Logic gates

In order to implement logical dependencies from external states as well, or to cascade weather stations, the device software has 16 logic gates. Each gate can have from one to a maximum of four inputs. For each logic gate, the type of logic operation 'AND', 'OR', 'exclusive OR', and 'AND with feedback' can be set. In addition, each input and the output can be operated normally or inverted.

For more complex functions it is possible to combine a number of logic gates. Feedback, i.e. connecting an output with an input of the same gate (poss. also via other logic gates or disabling modules) is not prevented by the configuration software. This does not interfere with the other device functions.

- i** Because feedback can lead to a very large number of telegrams, reasonable switch-on or switch-off delays should be set in such cases.
- i** As a rule, a logic operation is only evaluated when an input telegram is received. If a feedback with a cyclically sending output is created, it may occur that the device will send telegrams independently after the application is loaded or after a reset. In this case, too, switch-on or switch-off delays are highly advisable.
- i** With an 'AND with return' the value of the output is fed back internally to input 1. The result of this is that the output can only have the value '1' again if input 1 is set to '1' after the value '1' is already present on all of the other inputs. As soon as one of the other inputs is given the value '0', the output and thus input 1 is set to '0' because of the feedback.
Example: A luminaire that should first be switched on manually at dusk and switched off again automatically at dawn. Here the push-button is linked to input 1 and the limiting value of the twilight sensor is linked to input 2. After the twilight sensor has set input 2 to '1', the push-button on input 1 can be used to switch on the light. If the user forgets to switch the light off again manually, when daylight comes, the feedback ensures that input 1 is reset internally to '0'. Without this feedback the light would be switched on again automatically at the next twilight.

Parametrizing logic gates

The following settings must be made in order to use a logic gate:

- Activate the required number of "Logic gates" (max. 16) in the project design window "General".

On the parameter page "Logic gate *n*", make the following settings:

- Select the "Type of logic operation".
- In parameter "Send output when", select under what precondition the output object should be sent.
- In the parameter "Number of inputs", define a number of inputs between 1 and 4.
- Set the parameter "Output response" to 'Normal' or 'Inverted'.
- Set the "Switch-on delay".
- Set the "Switch-off delay".

- i** When using the delays, ensure that the time delays can be retriggered. Thus, with the switch-on delay, a "1" telegram at a gate input causes the delay time to be restarted over and over again. A "0" state at a gate input retriggers the switch-off delay again each time. Consequently, input states are only evaluated and output states are transmitted to the bus as a telegram only once the time delays have elapsed completely.
This should be observed particularly when input states are sent cyclically to the gate. For a combination of cyclic transmission and delays, the delay times must always be set smaller than the times for the cyclic transmission.

- In the parameter 'Cyclical sending of the output', set whether, and if so with what time interval, the output object should be sent.

On the parameter page "Logic gate n inputs", make the following settings for all the selected inputs:

- Under "Input n ", define whether an internal or an external input value should be assigned.
- Define the response "Input n " with 'Normal' or 'Inverted'.
- If an 'Internal input value' was selected for the appropriate input, the parameter "Assign input n " defines which value the input n assumes.
The logic gate has been completely parameterised.

Example of a logic gate configuration for awning protection

When controlling awnings, rain and wind monitoring is often required. If it rains, or the wind exceeds a certain limiting value, then the awning should be retracted after a short waiting time. This function can be implemented using a simple logic gate.

Precondition: Limiting values for precipitation and wind are configured in the ETS. The limiting values may not be transmitted cyclically.

Precondition: At least 1 logic gate must be configured.

- On the parameter page "Logic gate n ", set
The parameter "Type of logic operation" to 'OR',
The parameter "Send output at" to 'Every input event',
The parameter "Number of inputs" to '2 inputs',
The parameter "Output response" to 'Normal',
The parameter "Switch-on delay" to 'No delay' and
The parameter "Switch-off delay" to 'Delay on'.
- To increase sending security, set the cycle time of the parameter "Cyclical sending of the output" to, for example, '120 s'.
- On the parameter page "Logic gate n inputs", set
The parameter "Input 1" to 'Internal input value',
The parameter "Assign input 1" to 'Precipitation - LV n ',
The parameter "Response, input 1" to 'Normal',
The parameter "Input 2" to 'Internal input value',
The parameter "Assign input 2" to 'Wind speed - LV n ' and
the parameter "Response, input 2" to 'normal'.
- Connect the output of the logic gate (communication object) with a group address. Then, this group address is connected with a security input of the awning actuator, to which the appropriate awning output was assigned (additional information can be found in the documentation of the actuator).

The activation deactivation of the awning protection responds according to the following logic.

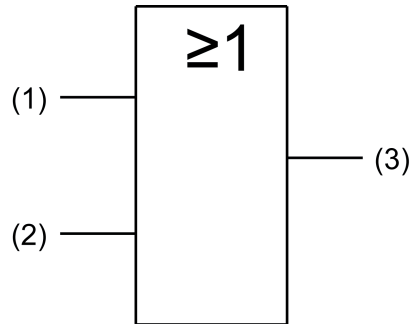

Figure 14: Activation / deactivation of awning protection

- (1) Limiting value n precipitation
- (2) Limiting value n wind speed
- (3) Output logic gate n for activation / deactivation of the awning protection.

- i** If the KNX/EIB system requires that the limiting values for precipitation and wind speed are sent cyclically to the bus, as in the above example, then an additional two logic gates must be enabled in the ETS. These additional gates (OR, 1 input) must then have the limiting values assigned to them separately from each other on the input side, and the output state must be transmitted cyclically to the bus. Optionally, switch-on delays and run-on times can be configured here.
- i** Refer to the application-orientated function description in this documentation for additional applications and combination options of logic functions to protect exterior systems against weathering influences. (see page 54).

4.2.3.4 Shading control

Introduction

The device provides automatic shading control for up to 8 facades. At the same time, the device automatically sends position values for the shading control to the KNX depending on the sun position. This function is based on information regarding the mounting location of the weather station, which is specified in the parameters.

Control of the shading achieves optimised use of the natural daylight whilst simultaneously avoiding strong glare. Automatic shading control can be achieved by automatic tracking of the Venetian blind slats or by control of the blind/shutter height according to the sun position.

The automatic shading control is based on the measured position of the sun, which, to the human observer, moves from the east through the south to the west in the course of the day. In the winter, the path of the sun is very flat and, in the summer, very steep.

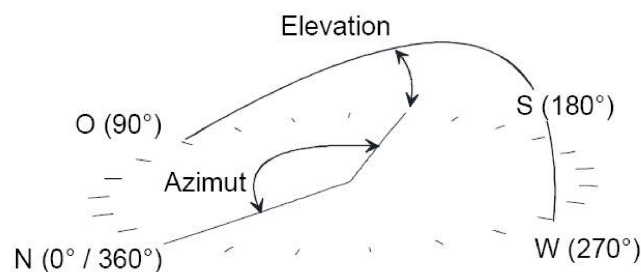

Figure 15: Flat solar path in the winter

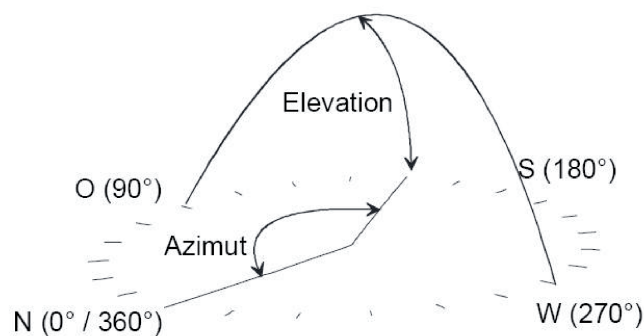

Figure 16: Steep solar path in the summer

The control of the blind/shutter height is possible both via 1-bit communication objects and via 1-byte communication objects. The parameters "format of the shading objects" and "type of blind/shutter object" define the data format of the communication objects for specifying the position values. These communication objects must be set according to the sun protection or Venetian blind position objects of the Venetian blind actuators.

Calculation of the sun position

The weather station calculates the position of the sun from the geographical position of the building, the current time and the current date.

This data required to calculate the sun position can be received via GPS/GLONASS if the function on the "General" parameter page is activated. The communication objects "GPS.Geographic longitude", "GPS.Geographic latitude" and "GPS.Location height" is enabled only if the GPS/Glonass is activated, which displays the received values.

When the parameter "Specification of position and height" on the parameter page "Shading control" is activated, then the values "geographical longitude in °", "geographical latitude in °" and "geographical height in m above NN" (NN = sea level) are specified in the ETS. These values are overwritten by the values received via GPS/Glonass. If the device does not receive any GPS/Glonass signals, the device calculates the sun position using the values specified in the ETS.

If GPS/Glonass is not activated, the "Specification of position and height" parameter is activated permanently. The "geographical longitude in °", "geographical latitude in °" and "geographical height in m above NN" parameters then describe the position of the mounting location of the weather station. The co-ordinates of the geographical position of the mounting location of the weather station can be found using various online planners and maps on the Internet. The latitude is counted from the Equator in a value range from -90° (south) to +90° (north). Longitude is determined in a range from -180° (west) to +180° (east) from the internationally-agreed Greenwich Meridian (defined zero meridian) (figure 17). For example, the geographical co-ordinates of the city of Berlin are a latitude of 52° and a longitude of 13°.

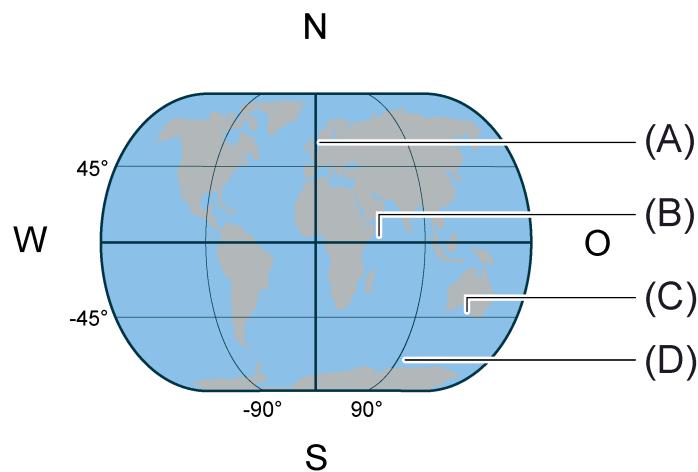

Figure 17: Geographical map of the world (simplified depiction)

- (A) Zero meridian
- (B) Equator
- (C) Latitude (e.g. -45°)
- (D) Longitude (e.g. 90°)

From the position of the observer, the position of the sun is described using two angles (figure 15). The azimuth specifies the angle between geographic north and a vertical circle through the centre of the sun.

The elevation (sun height) is the angle between the horizon and the centre of the sun from the point of view of the human observer.

Building orientation

Automatic shading control starts at the instant at least one of the four brightness sensors measures a light intensity above the settable threshold of the basic brightness. The "Basic brightness threshold" parameter decides whether the basic brightness threshold is preset internally via an additional parameter or externally via a communication object.

To ensure that the weather station can determine for which of the facades (up to eight) of the building shading is now required, the "orientation of the facade in °" and the "opening angle to the sun" must also be designed for each facade on the corresponding "facade n".

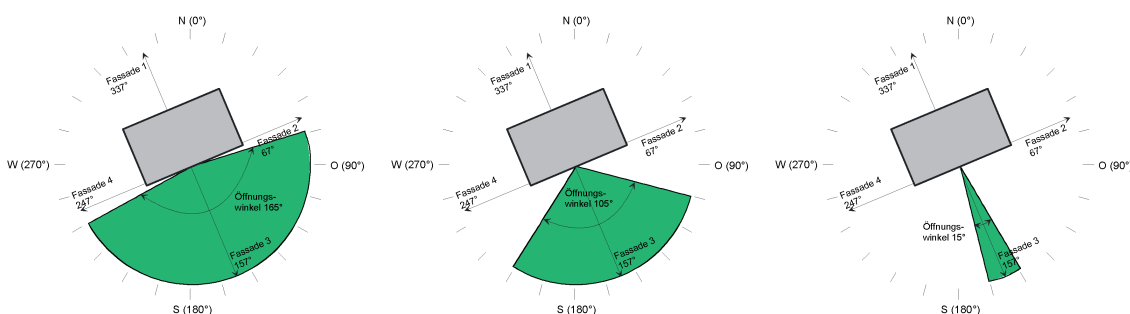

Figure 18: Facade orientation

The orientation a facade is determined by the compass directions of a vertical surface on each individual facade. The vertical should be shifted to the centre of the building using a parallel shift. As a result, it is quite likely that the same opening angle is assigned to different facades. The orientation can be found, for example, in the construction documents.

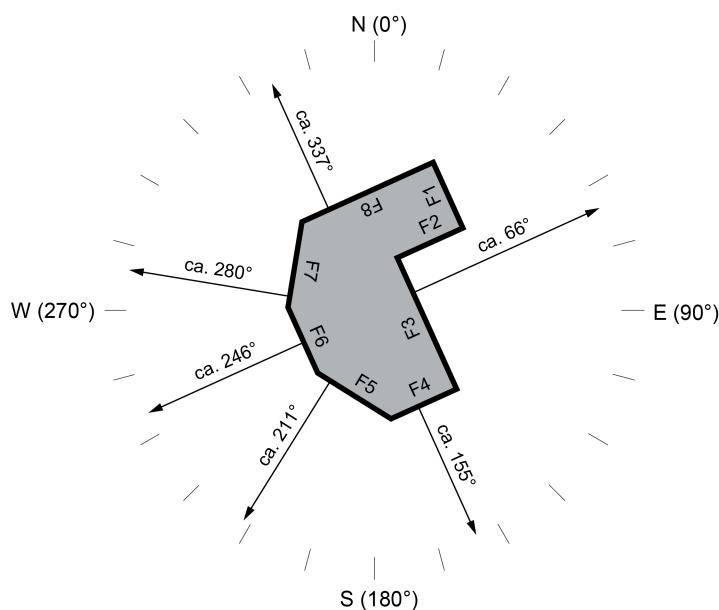

Figure 19: Facade orientation of a building with 8 facades

F1 Facade 1

...

F8 Facade 8

Facade	Opening angle
Facade 1 (F1)	approx. 66°
Facade 2 (F2)	approx. 155°
Facade 3 (F3)	approx. 66°
Facade 4 (F4)	approx. 155°
Facade 5 (F5)	approx. 211°
Facade 6 (F6)	approx. 246°
Facade 7 (F7)	approx. 280°
Facade 8 (F8)	approx. 337°

Opening angle to the sun

The opening angle to the sun determines in which area the sun azimuth must be located for an interfering glare to occur (figure 15).

The opening angle can either be specified permanently in the parameters in the ETS or can be changed during an operation by an external value transmitter. In this case, the external opening angle received via the communication object overwrites the configured value.

If a value of 180° is entered, this means that the Venetian blind of this facade will be lowered as soon as the sun begins to shine through the windows of this facade.

If an opening angle of 1° is entered, this means that the azimuth must be more or less vertical to the facade in order to lower the blind.

Venetian blind control

As described in the previous sections, the weather station sends a telegram for each individual facade when the brightness threshold has been exceeded and the sun's azimuth is located in the opening angle of the facade.

Depending on the "format of the shading objects" parameter setting, the "Shading facade *n*" communication object is either a 1-bit object or a 1-byte object, which is connected to the communication objects of the "Venetian blind positioning" objects.

The 1-bit object is connected to the "Long-time operation" communication object of the Venetian blind actuators.

The 1-byte object is connected to the "Venetian blind positioning" communication object. This allows the Venetian blinds to be moved.

The slats are positioned after an adjustable waiting time (parameter "Waiting time between shading and slat position"). A sufficient waiting time ensures that all Venetian blind drives have reached the lower end position. The waiting time should be adapted to the Venetian blind actuator.

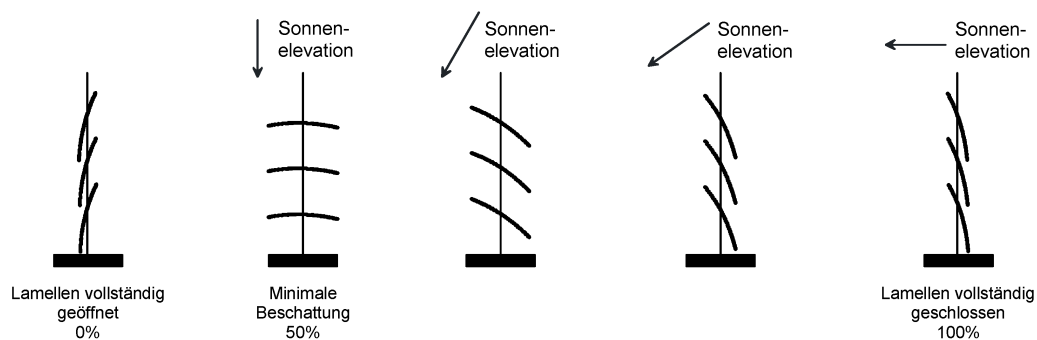

Figure 20: Slats are positioned according to the sun position

The slat positioning is dependent on the elevation of the sun. To achieve optimum protection against glare, the slats must be positioned vertically to the incoming sunlight. The calculation of the slat position is performed with percentage values according to the following formula:

$$\text{Slat position [\%]} = \text{Elevation} \times \{(\text{Min} - \text{Max}) / 90\} + \text{Max} + \text{Offset}$$

Here, Min and Max are the percentage positions of the slats for minimum and maximum shading. In addition, an offset can be entered for adjustment to different blinds/shutters.

The weather station will send slat positioning telegrams for as long as the sunlight penetration is above the configured value "Basic brightness for shading". The send criteria are either the change in elevation and / or a settable cycle time. With most Venetian blinds, the slats are adjusted by moving the blind/shutter briefly. This is usually connected with a clearly audible noise. For this reason, the elevation change or the cycle time for slat position should not be too small.

Blind/shutter height control

The weather station can adjust the blind/shutter height gradually according to the sun's elevation angle. This means that stepped shading can also be achieved with roller shutters or awnings which do not offer slat adjustment. As with slat control, the blind/shutter height control of a facade is only active when the light intensity of at least one of the four brightness sensors (north, east, south, west) has exceeded the "basic brightness value for shading" and the sun's azimuth is within the opening angle of the facade.

The weather station offers three thresholds for each facade. Each threshold can be activated individually. If the "threshold n " parameter is activated, one or two additionally parameters are visible depending on the "type of blind/shutter object".

If 1-bit type is selected, the "Sun position angle threshold n in °" parameter is visible for each activated threshold. As soon as the threshold value entered here is exceeded, the corresponding "Blind/shutter height, facade n threshold n " communication object sends a "1" to the KNX.

If 1-byte type is selected, the "Blind/shutter height threshold n %" parameter is also visible for each activated threshold. The weather station sends the value entered here to the KNX if the sun position angle exceeds the corresponding threshold.

- i The "Sun position angle threshold n in °" entered must be defined greater with the ascending order of the thresholds (threshold 1 -> threshold 2 -> threshold 3).

If the employed actuators offer the option of presetting the blind/shutter height via 1-byte objects, then the parameter "Type of blind/shutter height object" should be set to "1-byte (position)". If, instead of this, the actuators recall configurable values for the blind/shutter height

via 1-bit switching objects, the parameter can also be set to "1-bit":

- If the parameter "Type of blind/shutter height object" of the facade is set to "1-byte (position)", the weather station provides the 1-byte object "Blind/shutter height n position" for this facade.
The percentage value ("Blind/shutter height threshold n %" parameter) can then be defined for each activated threshold, to which the blind/shutter should move if this threshold is exceeded.
Beneath threshold 1, the weather station sends the value 100%.
- If the "Type of blind/shutter height object" parameter of the facade is set to "1-bit", then the weather station can offer this facade a 1-bit object "Blind/shutter height, facade n threshold n " for each active threshold. If a threshold is exceeded, then the corresponding object sends the value "1". The positions to be approached according to the thresholds must then be configured in the Venetian blind actuator. If necessary, the priorities of these 1-bit objects must be matched in the Venetian blind actuators.

If the shading of a facade is ended because the lighting intensity has fallen below the basic brightness or the azimuth has left the opening angle of the facade, then the 1-bit blind/shutter height objects are set to "0". The 1-byte blind/shutter height object is also set to "0%" accordingly.

The following table clarifies the relationship between the elevation, the threshold values and the sent object values for the blind/shutter height:

Elevation and threshold values	1-byte blind/shutter object	1-bit blind/shutter height object Threshold 3	1-bit blind/shutter height object Threshold 2	1-bit blind/shutter height object Threshold 1
El. \leq TH1	100 %	0	0	0
TH1 \leq El. $<$ TH2	X %	0	0	1
TH2 \leq El. $<$ TH3	Y %	0	1	1
TH3 \leq El.	Z %	1	1	1

Shading disabling for individual facades

The automatic shading can be disabled and enabled for each facade via a switching object. The "Disable facade control" parameter enables the "Disable facade n - shading control" communication object and additional parameters for defining the disabling function.

The parameter "Polarity of the disabling object" determines at which object value shading is disabled or enabled.

The other parameters define the behaviour of the "Shading facade n ", "Blind/shutter height n position" and "Slat position facade n " communication objects. During the definition, a distinction is made between switching from the enabled to the disabled state ("Behaviour at the beginning of the disabling function" parameter) and switching from the disabled state to the enabled state ("Behaviour at the end of the disabling function" parameter).

During disabling, no shading objects, no slat position objects and no blind/shutter height objects are sent.

After the end of disabling, the shading, blind/shutter height and slat position objects are sent again at the next event (cyclical sending or value change) of the appropriate facade. If "tracking" is configured for the reaction at the end of disabling, then the communication

objects are updated immediately.

Irrespective of the configured polarity of the disabling objects, all the facades are not disabled after a reset of the weather station. If no valid time and date values (GPS/Glonass or external clock) are available, then the shading objects will be set to "0", also when facades are disabled.

4.2.3.5 Sensor functions

Physical sensors of the weather station

The Weather station comprises a large number of sensors to detect the weather data. The physical sensors of the weather station are a wind sensor, four brightness sensors, a sensor to measure the global radiation, a capacitive precipitation sensor, a sensor to measure the air temperature and a piezoresistive MEMS sensor to measure the absolute air pressure at the mounting location. In addition, the relative humidity is measured using a hygro-thermosensor. Besides the physical sensors, a GPS receiver and a Glonass receiver with integrated RTC are installed in the station. Using these receivers, the Weather station is able to output the date and time, as well as geostationary data and the current sun level at the mounting location via KNX communication objects.

The following table lists the measuring ranges of the physical sensors installed in the Weather station.

Physical sensor	Measuring range	Measured value resolution	Measurement accuracy
Brightness (1-4)	0...150 kLux	1 kLux	+/- 4.5 kLux
Twilight	0...900 Lux	1 lux	+/- 10 Lux
Wind speed	0...40 m/s	0.1 m/s	+/- 1.5 m/s
Wind direction	1...360 °	1 °	+/- 10 °
Global radiation	0...1300 W/m ²	1 Watt/m ²	+/- 130 W/m ²
Precipitation	0/1 (No/Yes)	-	-
Temperature	-30...+60 °C	0.1 °C	+/- 1 °C
Relative humidity	0...100 %	0.1 %	+/- 10 %
Air pressure	300...1100 hPa	0.1 hPa	+/- 0.5 hPa
GPS / GLONASS	Date Time Location height Latitude Longitude	-	-

Measuring ranges of the sensors

- i** With the four brightness sensors, ensure that the Weather station outputs a brightness value of 0 Lux for received measured values below 1000 Lux.
- i** With the calculated twilight values, ensure that the Weather station outputs a brightness value of 900 Lux for determined values over 900 Lux.
- i** The weather station determines the location height by means of GPS. The measured location height is the mean sea level according to the geoid model. The location height cannot be output constantly on account of the system and fluctuates by several metres.

Using the values measured by the sensors, the Weather station is able to calculate additional physical variables. These include the maximum brightness of sensors 1 to 4, the absolute humidity, the felt temperature and the comfort.

The following table lists the measuring ranges of the physical values calculated in the Weather station.

Calculated variable	Measuring range	Measured value resolution	Measurement accuracy
Max. brightness of sensors 1 to 4	0...150 kLux	1 kLux	+/- 4.5 kLux
Absolute humidity	0...100 g/m ³	0.01 g/m ³	-
Felt temperature	-30...+60 °C	0.1 °C	+/- 1°C
Comfort	-	-	-

Measuring ranges of the calculated variables

4.2.3.5.1 Brightness

The weather station possesses a separate sensor for each direction. The total of four brightness sensors all have the same settings. The four detection areas of the sensors overlap somewhat in order to be able to follow the course of the sun properly.

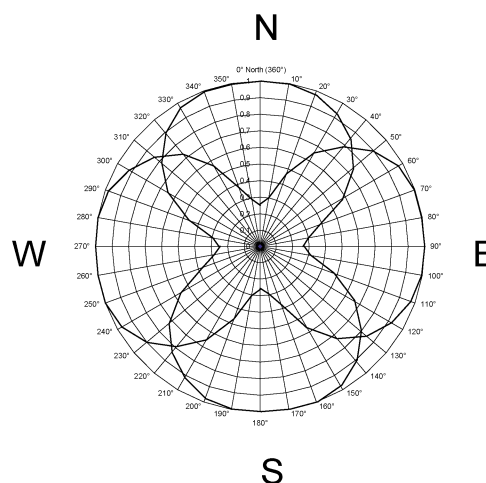

Figure 21: Circular chart Brightness detection

The measuring range covers 0 ... 150,000 Lux. The values are sent via 2-byte objects. For received brightness values below 1000 lux, the value 0 lux is output. To indicate the current illumination level, the measured value can be sent with an adjustable difference relative to the measuring range upper range value. Cyclic sending of the values is also possible. For each sensor, two settable limiting values are available, for each of which the weather station can transmit switching telegrams when they are exceeded or undershot. There is the option of setting these limiting values internally and permanently, or externally and variably, for example using visualisation software. The setting of the limiting values and the hysteresis is the same for all analogue sensors and is described in detail in the course of this technical documentation (see chapter 4.2.3.6. Measured and limiting values).

- i** Before the sensor can be configured, it has to be activated on the parameter page 'General'.

4.2.3.5.2 Twilight

To determine twilight, the weather station uses the four measured values of the brightness sensors. The twilight value range covers 0 ... 900 Lux and is sent via a 2-byte object. To indicate the current illumination level, the measured value can be sent with an adjustable difference relative to the measuring range upper range value. Cyclic sending of the values is also possible. Two settable limiting values are available, for each of which the weather station can transmit switching telegrams when they are exceeded or undershot. There is the option of setting these limiting values internally and permanently, or externally and variably, for example using visualisation software. A teaching function is also available, which can save the current measured value as a limiting value at the press of a button. The setting of the limiting values and the hysteresis is the same for all analogue sensors and is described in detail in the course of this technical documentation (see chapter 4.2.3.6. Measured and limiting values).

- i Before the sensor can be configured, it has to be activated on the parameter page 'General'.

4.2.3.5.3 Wind

The weather station has a wind sensor for determining the wind strength. The heated sensor is located on the underside of the basic housing of the Weather station. The temperature of the sensor is permanently regulated to a temperature higher than the environment.

- i For a correct function, the weather station requires the external supply voltage. If the external supply voltage fails during operation, all measured value objects (e.g., "Wind speed", "Temperature") and the objects to be monitored "Wind sensor unchanged", "Wind direction unchanged" and "No wind signal" are not updated. If the external supply is not available or insufficient, this can optionally be reported to the bus via the object "Supply voltage ok".
 When measured values for safety-relevant applications are used, such as wind alarm for awning or blind, an OR link must be established with the object "Supply voltage ok". (see page 57-58).

Wind speed

The added heating energy is used to determine the current wind speed. The configured measuring range is 0 ... 40 m/s. An accuracy of +/- 1.5 m/s is maintained at an outdoor temperature of -30°C ... +60°C. At deviating outdoor temperatures, the accuracy may be somewhat worse. If the weather station is mounted near an air outlet, for example, then the risk of icing cannot be excluded in the event of adverse weather conditions. To indicate the current wind speed, the measured value can be sent with an adjustable difference relative to the measuring range upper range value.

Wind direction

During wind measurement, the wind direction is determined via temperature measurement resistors, located in the interior of the cylindrical metal sensor. All the measured value resistors are thermally coupled to the measuring cylinder. When air flows around the cylinder, a temperature gradient forms at each of the temperature measurement resistors. The wind direction is determined from the ratio of all the temperature gradients of the individual measurement resistors in the interior of the measuring cylinder.

- i The wind direction "North" is output with 0°.
- i At a wind speed of 0 m/s, no wind direction can be determined. In this case, the output value of the wind direction is set to 0°.

The wind direction is displayed once via the 1-byte "Measured value wind direction [0...360°]" object, which sends the wind direction in ° to the KNX. If the appropriate wind conditions occur, the "Measured value, wind orientation" communication object sends the text to the KNX, which was entered previously on the "Wind direction" parameter page. The measured values can also be sent cyclically.

Wind area signal

In addition to the output of the wind direction in degrees or as text, the device can send a wind area signal to the KNX. When the "wind direction" function is activated on the "General" parameter page, the "wind area signal" parameter page is enabled. On this parameter page, an area can be defined using two limiting values for which the device sends a wind area signal to the KNX. The limiting values must always be defined so that "limiting value 1 in °" is the lower

limiting value and "limiting value 2 in °" is the upper limiting value of the range. The device does not perform any plausibility check of the limiting values.

The "Wind area signal" communication object sends a "1" telegram to the KNX when the wind direction corresponds to the defined area. At the same time, ensure that the wind area signal is not sent cyclically to the bus. It is sent once when the value changes.

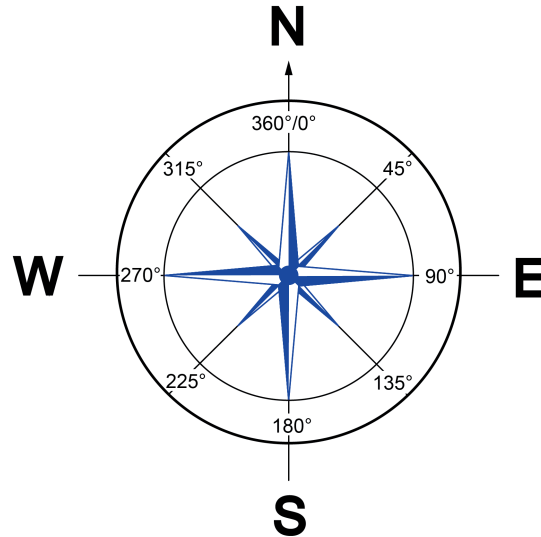

Figure 22: Wind rose

Example 1 for project design of the wind area signal

- "Wind direction" = activated

- "Limiting value 1 in °" = 45°

- "Limiting value 2 in °" = 90°

- "Hysteresis in °" = 10°

- "Activation area" = Measured value in area=ON, Undershoot of the lower LV+hyst.=OFF, exceeding of the upper LV+hyst.=OFF

The weather station measures the wind direction. The measured value is output via the "Measured value wind direction [0...360°]" communication object. According to example 1 for project design of the wind area signal, the device would send a wind area signal if the wind flows from the direction of north-east to east.

The device sends a "1" telegram (ON) to the KNX if the wind direction exceeds the lower limiting value or undershoots the upper limiting value. In example 1, the lower limiting value is 45° and the upper limiting value is 90°.

The device sends a "0" telegram (OFF) if the wind direction undershoots the lower limiting value minus hysteresis or exceeds the upper limiting value plus hysteresis. In example 1, the lower limiting value minus hysteresis is 35° and the upper limiting value plus hysteresis is 100°.

Example 2 for project design of the wind area signal

- "Wind direction" = activated

- "Limiting value 1 in °" = 315°

- "Limiting value 2 in °" = 22.5°

- "Hysteresis in °" = 10°

- "Activation area" = Measured value in area=ON, Undershoot of the lower LV+hyst.=OFF, exceeding of the upper LV+hyst.=OFF

The weather station measures the wind direction. The measured value is output via the "Measured value wind direction [0...360°]" communication object. According to example 2 for project design of the wind area signal, the device would send a wind area signal if the wind flows from the direction of north-west to north-east.



The device sends a "1" telegram (ON) to the KNX if the wind direction exceeds the lower limiting value or undershoots the upper limiting value. In example 2, the lower limiting value is 315° and the upper limiting value is 22.5°.

The device sends a "0" telegram (OFF) if the wind direction undershoots the lower limiting value minus hysteresis or exceeds the upper limiting value plus hysteresis. In example 2, the lower limiting value minus hysteresis is 305° and the upper limiting value plus hysteresis is 32.5°. In the example, the wind area goes over the 0-transition.

In the parameters of the device, you define when the wind area signal is activated. The activation of the wind area signal depends on the following criteria:

- Is the measured wind direction within the defined area?
(The defined area ranges from the lower limiting value (limiting value 1), from which the hysteresis value is subtracted, to the upper limiting value (limiting value 2), to which the hysteresis value is added.)
- Is the lower limiting value minus hysteresis undershot?
- Is the upper limiting value plus hysteresis exceeded?

The values themselves are sent in the same manner for all of the sensors. Two settable limiting values are available, for each of which the weather station can transmit switching telegrams when they are exceeded or undershot. There is the option of setting these limiting values internally and permanently, or externally and variably, for example using visualisation software. The setting of the limiting values and the hysteresis is the same for all analogue sensors and is described in detail in the course of this technical documentation (see chapter 4.2.3.6. Measured and limiting values).

-  Before the sensor can be configured, it has to be activated on the parameter page 'General'.
-  The wind direction cannot be saved as limiting value (Teach-In).
-  The wind signal can be checked for plausibility with the aid of the monitoring function.

4.2.3.5.4 Precipitation

To detect precipitation, the weather station is equipped with a capacitive sensor, which is aligned to a northerly direction using an Allen screw. If precipitation, e.g. heavy fog, rain or snow appears there, then it is detected via a change in capacity. Unlike the weather station's other sensors, this value is not analog, but rather binary: 'Precipitation' or 'No precipitation'. Therefore the measured result is output directly via the limiting values. A measured value object is not available.

Operation of the weather station is only possible if an external supply voltage is connected. The sensor is equipped with a heater to provide faster drying after a rain shower and to protect against icing in the specified temperature range.

If there is a voltage failure, the limiting values for precipitation are set to rain and the appropriate communication objects send the command to the bus twice. After voltage return, precipitation is evaluated according to the configuration and also sent to the bus twice.

The setting for the limiting values is the same for all analogue sensors, and is described in detail in the course of this technical documentation (see chapter 4.2.3.6. Measured and limiting values).

- i For a correct function, the weather station requires the external supply voltage. If the external supply is not available or insufficient, the device reports "Precipitation" to the bus. If the external supply voltage fails during operation, the KNX telegram will be sent twice.

- i Before the sensor can be configured, it has to be activated on the parameter page 'General'.

4.2.3.5.5 Air humidity

Relative humidity

The weather station has a hygro-thermosensor for determining the relative humidity. This sensor is located on the underside of the basic housing of the Weather station. The preconfigured measuring range is from 0 to 100 % and is shown with an accuracy of +/- 10 %. The sensor for measuring humidity is located in a miniature housing, in which an air exchange takes place, allowing the hygro-thermosensor to react to a change in humidity within a few seconds.

To indicate the current relative humidity, the measured value can be sent with an adjustable difference relative to the measuring range upper range value. Cyclic sending of the values is also possible. The values themselves are sent in the same manner for all of the sensors. Two settable limiting values are available, for each of which the weather station can transmit switching telegrams when they are exceeded or undershot. There is the option of setting these limiting values internally and permanently, or externally and variably, for example using visualisation software. The setting of the limiting values and the hysteresis is the same for all analogue sensors and is described in detail in the course of this technical documentation (see chapter 4.2.3.6. Measured and limiting values).

i Before the sensor can be configured, it has to be activated on the parameter page 'General'.

Absolute humidity

Using a software module, the Weather station is able to calculate the absolute humidity. Using the measured air temperature values in °C and the relative humidity in %, the absolute humidity is calculated in g/m³. The calculated value can be specified in an interval of 0 to 100 g/m³. Two settable limiting values are available, for each of which the weather station can transmit switching telegrams when they are exceeded or undershot. There is the option of setting these limiting values internally and permanently, or externally and variably, for example using visualisation software. The setting of the limiting values and the hysteresis is the same for all analogue sensors and is described in detail in the course of this technical documentation (see chapter 4.2.3.6. Measured and limiting values).

i Before the sensor can be configured, it has to be activated on the parameter page 'General'.

4.2.3.5.6 Temperature

For temperature detection, a temperature sensor is built into the weather station that determines the temperature at the location. The measuring range covers $-30\dots+60\text{ }^{\circ}\text{C}$, and is sent via a 2 byte object. To indicate the current temperature, the measured value can be sent with an adjustable difference relative to the measuring range upper range value. Cyclic sending of the values is also possible. The values are sent in the same manner for all of the sensors. Two settable limiting values are available, for each of which the weather station can transmit switching telegrams when they are exceeded or undershot. There is the option of setting these limiting values internally and permanently, or externally and variably, for example using visualisation software. A teaching function is also available, which can save the current measured value as a limiting value at the press of a button. The setting of the limiting values and the hysteresis is the same for all analogue sensors and is described in detail in the course of this technical documentation (see chapter 4.2.3.6. Measured and limiting values).

- i** Before the sensor can be configured, it has to be activated on the parameter page 'General'.
- i** Direct sunlight affects the temperature measurement.
- i** For a correct function, the weather station requires the external supply voltage. If the external supply voltage fails during operation, all measured value objects (e.g., "Wind speed", "Temperature") and the objects to be monitored "Wind sensor unchanged", "Wind direction unchanged" and "No wind signal" are not updated. If the external supply is not available or insufficient, this can optionally be reported to the bus via the object "Supply voltage ok".
When measured values for safety-relevant applications are used, such as wind alarm for awning or blind, an OR link must be established with the object "Supply voltage ok". (see page 57-58).

Felt temperature

The felt temperature describes the ambient temperature as perceived by a person. The value output via the communication object "Felt temperature" is a rough orientation of how the weather feels at the mounting location of the weather station. The perception of the temperature is very subjective and is dependent on multiple external influences.

Some example influence factors are listed below:

- Wind speed at the person's location
- Air temperature
- Level of activity of the person
- Physical size and weight
- Sunlight penetration

Under certain environmental influences, the calculation of the felt temperature is not carried out. In these cases, the temperature value measured using the temperature sensor is also output via the communication object "Measured value, felt temperature". The felt temperature cannot be determined when the wind speed is less than 2 m/s or the ambient temperature prevailing at the mounting location exceeds $33\text{ }^{\circ}\text{C}$.

- i** Note that a valid value of the felt temperature is output on the KNX after a time delay of approximately 2 minutes due to the internal calculation in the device.
- i** The felt temperature cannot be determined when either the measured wind speed is below 2 m/s or the measured temperature is above $33\text{ }^{\circ}\text{C}$. In such cases, the measured temperature is output as the felt temperature.

Two settable limiting values are available, for each of which the weather station can transmit switching telegrams when they are exceeded or undershot. There is the option of setting these

limiting values internally and permanently, or externally and variably, for example using visualisation software. A teaching function is also available, which can save the current measured value as a limiting value at the press of a button. The setting of the limiting values and the hysteresis is the same for all analogue sensors and is described in detail in the course of this technical documentation (see chapter 4.2.3.6. Measured and limiting values).

- i Before configuration on the "Felt temperature" parameter page, the function has to be activated on the parameter page 'General'.

4.2.3.5.7 Comfort

The Comfort describes how a person feels. The way people feel is strongly dependent on various external influence factors.

Some example influence factors are listed below:

- Air temperature
- Wind speed
- Relative humidity of the air

After the activation of the "Comfort" function, two communication objects are enabled. These include the appropriate communication object "Comfort". This outputs the status of the external climatic conditions at the mounting location of the weather station. When a logical 1 is sent to the bus, the conditions for people are pleasant. The comfort range stretches from a relative humidity level of 35 to 70%, roughly between 18 °C and 24 °C (figure 23).

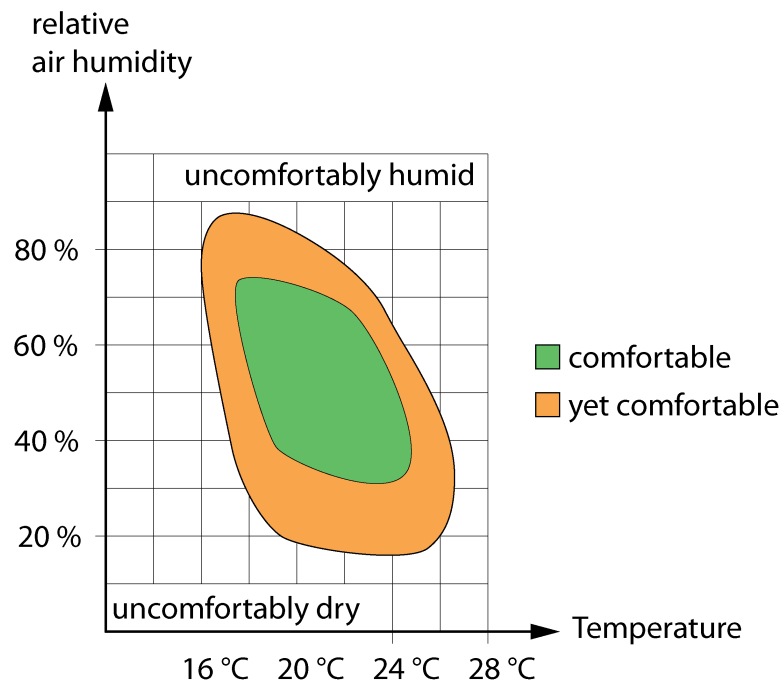

Figure 23: Comfort curve

Oppressiveness

Using the second available communication object "Oppressiveness", the Weather station evaluates the climatic conditions at the mounting location of the weather station using the humidity to temperature ratio relative to oppressiveness. Oppressiveness occurs as a subjective feeling of people in warm and wet climates (figure 24).

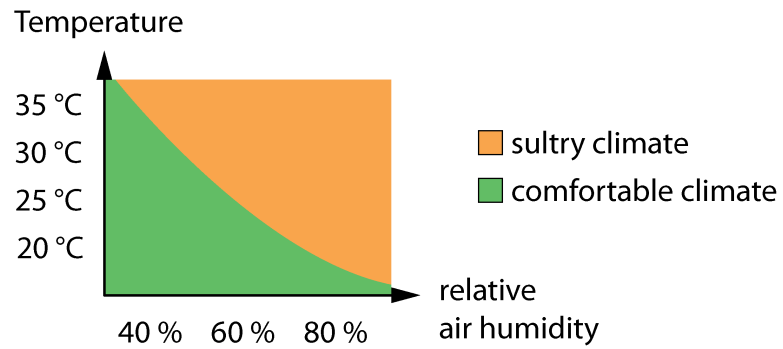

Figure 24: Oppressiveness - characteristic curve

The polarity, with which the status of comfort and oppressiveness is sent to the bus, is permanently implemented (comfortable / oppressive = "1"; uncomfortable / not oppressive = "0"). After activation of the "Comfort" function, the project designer can set on the "Comfort" parameter page whether and how frequently the comfort and oppressiveness status are cyclically sent to the bus. In addition, the status can also be sent to the bus if there is a change in value. Moreover, it is possible to configure the adjustment of a tolerance range. In so doing, the project designer can define whether the output should be insensitive, sensitive or according to the standard.

- i** Before configuration on the "Comfort" parameter page, the function has to be activated on the parameter page 'General'.

4.2.3.5.8 Air pressure

The measurement of the current air pressure at the mounting location is carried out using a piezoresistive MEMS sensor. This sensor is located in the interior of the basic housing of the Weather station. The preconfigured measuring range is from 300 to 1100 hPa and is shown with an accuracy of +/- 0.5 hPa.

To indicate the current air pressure, the measured value can be sent with an adjustable difference relative to the measuring range upper range value. Cyclic sending of the values is also possible. The values themselves are sent in the same manner for all of the sensors. Two settable limiting values are available, for each of which the weather station can transmit switching telegrams when they are exceeded or undershot. There is the option of setting these limiting values internally and permanently, or externally and variably, for example using visualisation software. The setting of the limiting values and the hysteresis is the same for all analogue sensors and is described in detail in the course of this technical documentation (see chapter 4.2.3.6. Measured and limiting values).

- i Before the sensor can be configured, it has to be activated on the parameter page 'General'.

4.2.3.5.9 Global radiation

The weather station possesses a silicon PIN photodiode to measure the global radiation. This is located in the interior of the basic housing of the Weather station. The solar radiation is run via a photoconductor integrated in the light-permeable sensor head towards the photodiode. The preconfigured measuring range is from 0 to 1300 W/M² and is shown with an accuracy of +/- 130 W/m².

To indicate the global radiation, the measured value can be sent with an adjustable difference relative to the measuring range upper range value. Cyclic sending of the values is also possible. The values themselves are sent in the same manner for all of the sensors. Two settable limiting values are available, for each of which the weather station can transmit switching telegrams when they are exceeded or undershot. There is the option of setting these limiting values internally and permanently, or externally and variably, for example using visualisation software. The setting of the limiting values and the hysteresis is the same for all analogue sensors and is described in detail in the course of this technical documentation (see chapter 4.2.3.6. Measured and limiting values).

- i Before the sensor can be configured, it has to be activated on the parameter page 'General'.

4.2.3.5.10 GPS/Glonass

The weather station is equipped with a GPS / Glonass receiver with integrated Real Time Clock. The receiver can evaluate both received GPS data and also Glonass data.

- i** After the power supply of the weather station has been switched on, it takes a few minutes for the first satellite data to be available and be displayed.
- i** The mounting position and the local environmental conditions can influence the received measured values.

Under the best possible conditions, the GPS/Glonass sensor can measure the CEP (50%) dimension, which is a variable of the system accuracy, to an accuracy of 3 metres. The Circular Error Probable (CEP) designates the radius of a circle, in which 50 % of all the measured values are located.

The accuracy of the data received via GPS/Glonass is very dependent on various influences. Variations in signal quality are perfectly normal. A decline in the quality of the received signal can be caused by shading, refraction, attenuation or reflection. These influencing factors, with a negative effect on reception, should be taken into account when selecting the mounting location (see chapter 2.3. Fitting and electrical connection) and avoided if possible.

The time and date can be output using two 3-byte communication objects.

As soon as signals from at least 3 satellites are received, the position of the mounting location of the weather station can then be read out via the KNX. When GPS/Glonass is activated, two communication objects are available to output the mounting position. One displays the geographical longitude and the other outputs the geographical latitude.

In addition, when a signal is received from at least 4 satellites, the height of the mounted weather station can be read out relative to the WGS84 ellipsoid. The height can be read out via the 4-byte communication object "GPS.Location Height". The location height is not output constantly and may fluctuate by several metres. This behaviour is not caused by a malfunction of the device, but by the underlying conditions of the height determination with GPS.

The data for the calculation of the azimuth and the elevation is also received via GPS / Glonass. These values, required primarily for the automatic shading control, are only received when GPS / Glonass was activated in the parameters of the Weather station. For display purposes, the elevation and azimuth measured values can be sent cyclically.

- i** Should the parameter "Cycl. sending of the measured value (x10s)" be set to the value "0", no values received via GPS/Glonass are sent to the bus.
- i** The rate at which the date and time are sent to the KNX is defined by the parameter "Cyclical sending of date/time interval" on the parameter page "Time".

4.2.3.6 Measured and limiting values

Sending the measured values

All the measured values of the analogue sensors (except comfort and precipitation) can be sent cyclically and/or when the measured value changes. The values are sent on a change independently of the cyclical sending. Accordingly, sending on a change also takes place between the cyclical sending telegrams.

- i The measured value of the precipitation sensor is processed in the form of the two limiting values. The setting is described under Limiting values.
- i The comfort status can be sent cyclically.

Setting sending of the analogue measured values when there is a change

The corresponding sensor must be activated under the general settings, and the parameters must be visible in the ETS.

- On the parameter page of the sensor to be configured (e.g. brightness sensor), set the parameter "Send measured value on" to either '0.5% measured value difference', '1% measured value difference', '3% measured value difference' or '10% measured value difference'. The percentage is relative to the upper range value of the specific measuring range of the sensor.
 Example: The setting for the twilight sensor (measuring range 0...900 Lux) is sending at 1% measured value difference. Only when the signal changes by about 5 lux upwards or downwards will the object be sent again.

- i Because the measured value difference of the temperature sensor (measurement range -30...60°C) has its zero point shifted into the negative, it is calculated with an upper range value of 90 K.
- i A general sending delay of 10 seconds is defined permanently.

Cyclic sending of the measured values

All measured value objects of the analogue sensors can be sent cyclically using the parameter 'Cycl. sending of the measured value'.

- i Measured value telegrams 'Sending of measured value for value change' that are generated have no effect on the cycle time for the cyclic sending of limiting value objects.
- i As it works in purely binary form, the precipitation sensor does not have a measured value object. Its measured values are processed in the form of two limiting values.

Setting cyclical sending of a measured value

The sensor for which cyclic sending of the measured value is to be set is 'Activated' on the parameter page 'General'

- On the parameter page of the sensor (e.g. brightness sensor), configure the parameter "Cycl. sending of the measured value *n*". A value between 0 and 120 can be set.

- i The set value (0...120) is multiplied by 10 seconds to obtain the cycle time.
- i '0' means that the measured value is not sent cyclically.

The measured value is sent at the set interval.

Limiting value settings

All of the analogue measured values of the sensors (except comfort) can be assigned with two limiting values. This makes it possible to trigger actions when the adjustable limits are exceeded

or fallen below. For example, it is possible to lower shutters to protect against glare once a certain brightness is reached.

The following settings are available to configure an activated limiting value:

- Select "Limiting value n " e.g. in kLux or °C, according to the list.
- Select "Hysteresis of limiting value n " e.g. in kLux or K, according to the list.
- Specify the response in the event of exceeding and falling below in parameter "Activation limiting value n " from the list.
- Using the parameter "External limiting value n ", specify if necessary whether the limiting value is to be specified externally.
- Define the "Switch-on delay limiting value n " according to the list.
- Select the "Switch-off delay limiting value n " according to the list.
- Define whether "Sending of limiting value n for value change" should take place (analogue sensors).
- Define whether, and if so, at what interval the "Cycl. sending of limiting value n " should take place.

i In the case of the binary precipitation sensor, the measurement result is directly treated as a limiting value. The parameters "Hysteresis limiting value n ", "Activation limiting value n " and "External limiting value n " are not available for this sensor.

Types of limiting value specification

There are three ways to define a limiting value:

- Limiting value specification via the parametrization. This value sets itself after initialisation or after a download. The configured limiting value can be overwritten via an external object or the teaching function.
- Limiting value specification via an external object. The limiting value received via the communication object overwrites the configured limiting value permanently.
- Limiting value specification via the teaching function. This function makes it possible to specify the current measured value as the limiting value by using a telegram to a 1-bit object, for example by pressing an external push-button. This value overwrites the configured limiting value permanently.

i After overwriting of the limiting value by an external object or using a teaching function, this newly taught limiting value is stored in the weather station and has priority until a re-initialisation of the weather station is performed through a bus voltage failure or a new download via the ETS.

Setting limiting value specification via parametrization

The limiting value specification for the measured values 'Brightness 1', 'Brightness 2', 'Brightness 3', 'Brightness 4', 'Max. brightness 1 to 4', 'Twilight', 'Max. brightness 1 to 4 and twilight', 'Temperature' and 'Wind' are set using the parameter 'Limiting value n '.

The desired *measured value* must be activated under the general settings, and the parameters must be visible in the ETS.

'Limiting value 1 activated' or 'Limiting values 1 and 2 activated' is set for the *measured value*.

- Highlight '*Measured value* limiting value 1' or '*Measured value* limiting value 2'.
- On the parameter page "Limiting value n ", select the required limiting value from a list of predefined limiting values.

i This value is loaded to the device during initialization and renewed download.

i The set value is retained until it is overwritten by an external value.

Hysteresis of the limiting values

The weather station has two limiting values for each analog measured value. Each limiting value has an adjustable hysteresis and a definition of the response when the value is exceeded or

undershot. The hysteresis itself serves to prevent frequent switching backwards and forwards when there is a measured value in the approximate area of the limiting value. This can be used, for example, to prevent a Venetian blind from constantly moving up and down. For this reason, the selected hysteresis should be as great as possible. These circumstances are explained in the following diagrams...

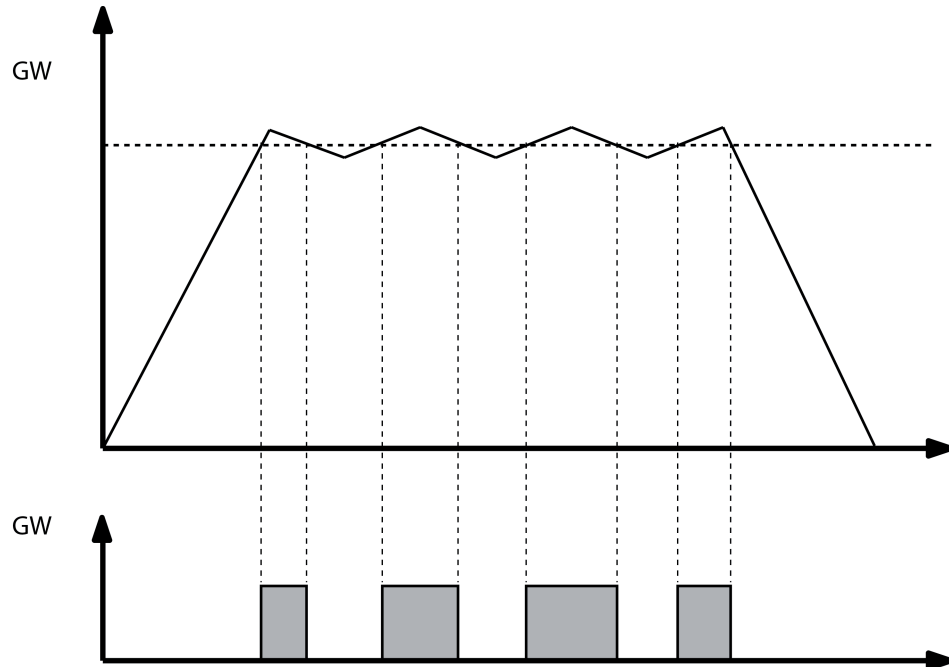

Figure 25: Frequency of switching without hysteresis

One can see here that when no hysteresis is incorporated the limiting value object changes its state each time the value is undershot or exceeded. This is different if you parameterise a change of state from '1' to '0' only when the limit value is undershot by the measured value minus hysteresis.

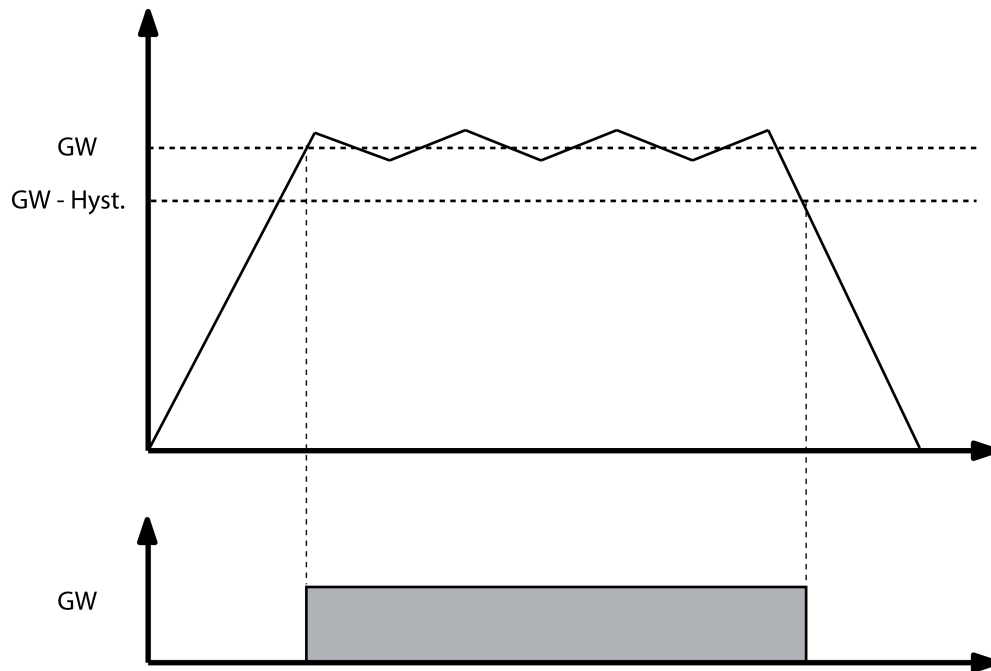

Figure 26: Frequency of switching with hysteresis parameterised.

- i Select the size of the hysteresis so that the beginning of the measuring range is not reached or fallen below, and the upper range value is not reached or exceeded, because otherwise a change of state will take place only once, and cannot take place again until there is a re-initialisation.

Setting the hysteresis of the limiting value

The hysteresis of the measured values 'Brightness 1', 'Brightness 2', 'Brightness 3', 'Brightness 4', 'Max. brightness 1 to 4', 'Twilight', 'Max. brightness 1 to 4 and twilight', 'Temperature' and 'Wind' is set using the parameter 'Hysteresis limiting value *n*'

The desired *measured value* must be activated under the general settings, and the parameters must be visible in the ETS.

'Limiting value 1 activated' or 'Limiting values 1 and 2 activated' is set for the *measured value*.

- On the parameter page of the appropriate "*Measured value* limiting value *n*", set the parameter 'Hysteresis limiting value *n*' e.g. in kLux to the required value.

The hysteresis is set.

Response of the limiting value object when the limiting value is exceeded and undershot

For the parameter 'Activation of limiting value *n*', a direction-dependent setting is made for how the limiting value responds when the set limiting value is exceeded or undershot. If, for example, "Undersh. LV=ON, exceed LV + Hyst. = OFF" is selected, the limiting value object is then set to '1' if the limiting value is fallen below, and the limiting value object will first be set to '0' when the limiting value plus hysteresis is exceeded.

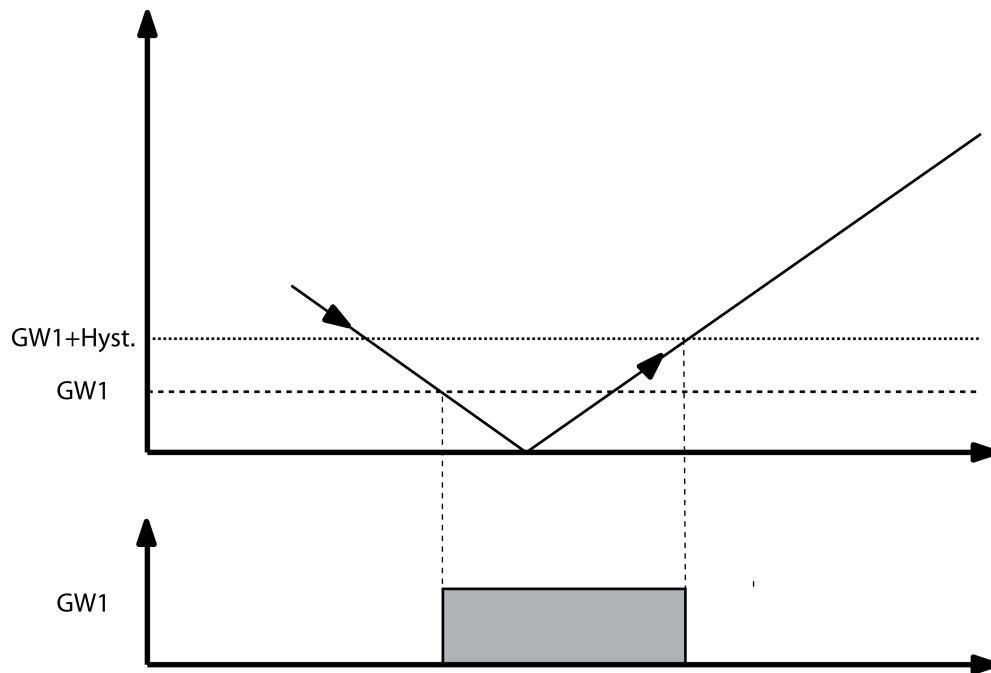

Figure 27: Activation of limiting value

If 'No telegram' i.e. no telegram is configured for a run-through, the cyclical sending of the limiting value n is also prevented when this function is activated. The cyclical sending of this limiting value remains interrupted until the opposite state is reached once again.

Example: Undersh. is configured LV=ON, exceed LV+hyst.=no telegr.

- An "ON" telegram is sent when the limiting value is fallen below. If "Cycl. sending of limiting value n " is configured with '10', then this "ON" telegram is additionally sent every 100 seconds (10 sec x 10).
- If the limiting value plus hysteresis is fallen below, no telegram is sent and cyclical sending is suppressed, too.
- If the limiting value is fallen below again, an "ON" telegram is sent in turn and the cyclical sending of this "ON" telegram is reactivated, too.

Setting response of the limiting value object when the limiting value is exceeded and undershot

The sensor for which the limiting value is to be set must be 'Activated' under the parameter page 'General'

On the parameter page of the sensor, for example 'Twilight', the desired 'Limiting value n activated' is set

To determine the behaviour of the limiting value object, the parameter "Activation of limiting value n " makes the following variants available...

- Exceed LV = ON, Undershoot LV-hyst.=OFF
- Exceed LV = OFF, Undershoot LV-hyst.=ON
- Undershoot LV = ON, Exceed LV+hyst.=OFF
- Undershoot LV = OFF, Exceed LV+hyst.=ON
- Exceed LV = ON, Undershoot LV-hyst.=no telegr.
- Exceed LV = OFF, Undershoot LV-hyst.=no telegr.
- Undershoot LV = ON, Exceed LV+hyst.=no telegr.
- Undershoot LV = OFF, Exceed LV+hyst.=no telegr.

- Exceed LV = No telegr., Undershoot LV-hyst.=OFF
 - Exceed LV = No telegr., Undershoot LV-hyst.=ON
 - Undershoot LV = No telegr., Exceed LV+hyst.=OFF
 - Undershoot LV = No telegr., Exceed LV+hyst.=ON
- The desired response of the limiting value is set.

i If 'No telegr.' is configured for a state, then the sending of the limiting value object 'On change and cyclically' is suppressed for the time range during which the condition is fulfilled.

Specifying limiting values via external objects

If you want limiting values to be adjustable during ongoing operation of the building, then the parameter 'External limiting value *n*' can be set to '16 bit value' or '8 bit value'. These communication objects 'External limiting value *n*' (16-bit) and 'External limiting value *n* [%]' (8-bit) can be linked, for example, with the value transmitter objects of an external push-button.

- i** If the value specification is triggered by a push-button sensor, this push-button sensor should be configured in such a way that it first sends the configured value after a long button-press (more than 3 seconds).
- i** Limiting value specification via external objects is not available for the measured value 'Precipitation'.

Limiting value specification via teaching function

One option of using the current measured value as a new limiting value without knowing the numerical value themselves is to set the parameter 'External limiting value *n*' to 'Store limiting value via switching object (teaching)'. This setting enables the object 'External limiting value *n* (teaching)'. The weather station assumes the last measured value as the new limiting value as soon as a telegram with the value "1" is sent to this communication object. Telegrams with the value "0" are ignored.

The new limiting value set with the teaching function remains unchanged until a new presetting is made. Even a bus voltage failure will not reset the new limiting value. An ETS programming operation resets the limiting value automatically to the ETS presettings if this is provided for in the configuration.

- i** If the teaching function is to be triggered by a push-button sensor, then this push-button sensor should be configured in such a way that it sends the value "1" only after it is pressed for a longer period (over 3 seconds).
- i** The teaching function is not available for some measured values (e.g. precipitation).

Setting limiting value specification via external objects or by means of teaching

Limiting value specification via an external object for the measured values 'Brightness 1', 'Brightness 2', 'Brightness 3', 'Brightness 4', 'Max. brightness 1 to 4', 'Twilight', 'Max. brightness 1 to 4 and twilight', 'Temperature' and 'Wind' is set by means of the parameter 'External limiting value *n*'.

The desired *measured value* must be activated under the general settings, and the parameters must be visible in the ETS.

'Limiting value 1 activated' or 'Limiting values 1 and 2 activated' is set for the *measured value*.

- On the parameter page "*Measured value* limiting value 1" or "*Measured value* limiting value 2", it is possible to define whether the limiting value is specified via an external object and, if yes, using which data format. It is possible to choose between a '16-bit value', an '8-bit value' or whether 'Save limiting value via switching object (teaching)' is taught in.

i The set value overwrites the limiting value specification via configuration until it is overwritten by an external value.

- i** This value is overwritten by the value 'Limiting value specification via configuration' during initialisation and any new download.

Switch-on and switch-off delay of the limiting values

All limiting values of the weather station can be switched on or off with a delay. It should be noted here that not only is the transmission affected on change of this delay, but the cyclical transmission of the limiting value object, too.

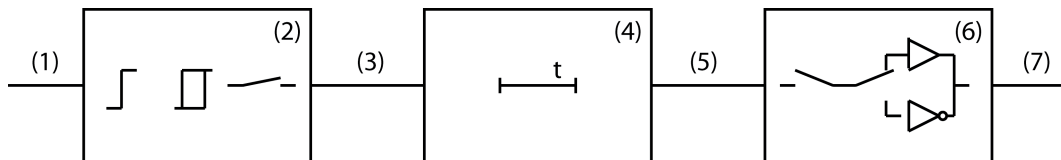

Figure 28: Block diagram for switch-on and switch-off delay

- (1) Measured value
- (2) Limiting value and hysteresis processing
- (3) Internal limiting value
- (4) ON delay and OFF delay
- (5) Delayed, internal limiting value
- (6) Processing of cyclic sending, sending when change, activation of limiting value
- (7) Limiting value object

When the value of an internal limiting value (3) changes from '0' to '1', the parameter value of the switch-on delay is evaluated. When the value of an internal limiting value changes from '1' to '0', the parameter value of the switch-off delay is evaluated. If "no delay" is set, then the value of the delayed internal limiting value immediately takes the value of the internal limiting value. When a delay time is set, a timer with the delay time (4) is loaded and started. Only when it expires is the value of the internal limiting value accepted as the value for the delayed internal limiting value (5) and the limiting value sent in accordance with the configuration. The cyclic sending is also affected by this delay. If the internal limiting value changes before the timer expires, then it is stopped and the limiting value remains unchanged. Consequently, no limiting value telegram initiated by the parameter 'Sending of limiting value n for value change' is sent, either.

Setting the switch-on delay

For all limiting values, including the states of the precipitation sensor, a switch-on delay can be set using the parameter 'Switch-on delay limiting value n '.

The desired *measured value* must be activated under the general settings, and the parameters must be visible in the ETS.

'Limiting value 1 activated' or 'Limiting values 1 and 2 activated' is set for the *measured value*.

- On the parameter page "*Measured value* limiting value 1" or "*Measured value* limiting value 2", it is possible to define whether the limiting value is to be switched on and, if yes, after which time delay. The appropriate time should be selected from a list with predefined values (e.g. 1 s, 5 s or 60 min).

The switch-on delay is set.

Setting the switch-off delay

For all limiting values, including the states of the precipitation sensor, a switch-off delay can be set using the parameter 'Switch-off delay limiting value *n*'.

The desired *measured value* must be activated under the general settings, and the parameters must be visible in the ETS.

'Limiting value 1 activated' or 'Limiting values 1 and 2 activated' is set for the *measured value*.

- On the parameter page "*Measured value* limiting value 1" or "*Measured value* limiting value 2", it is possible to define whether the limiting value is to be switched off and, if yes, after which time delay. The appropriate time should be selected from a list with predefined values (e.g. 1 s, 5 s or 60 min).

The switch-off delay is set.

Setting sending of a limiting value of an analogue sensor when there is a change

The limiting values of the measured values 'Brightness 1', 'Brightness 2', 'Brightness 3', 'Brightness 4', 'Max. brightness 1 to 4', 'Twilight', 'Max. brightness 1 to 4 and twilight', 'Temperature' and 'Wind' can be sent when their value changes using the parameter 'Send limiting value when changed'.

The desired *measured value* must be activated under the general settings, and the parameters must be visible in the ETS.

'Limiting value 1 activated' or 'Limiting values 1 and 2 activated' is set for the *measured value*.

- On the parameter page "*Measured value* limiting value 1" or "*Measured value* limiting value 2", it is possible to define whether the limiting value is to be sent when a value changes. The sending of the limiting value is implemented when this parameter is set to "Yes".

The value is sent on a change of state from '0' to '1' or from '1' to '0'.

- i The object value is sent again if the limiting value even occurs again, even if the reversed event is parametrized to 'No telegr.'

Setting sending of a limiting value of the precipitation sensor when there is a change

Because the precipitation only has the states 'Precipitation' and 'No precipitation', its states are sent via the two limiting value objects

'Precipitation' must be activated under the general settings, and the parameters must be visible in the ETS.

'Limiting value 1 activated' or 'Limiting values 1 and 2 activated' is set for the 'Precipitation'.

- On the parameter page "Precipitation limiting value 1" or "Precipitation limiting value 2", it is possible to define whether the limiting value is to be sent when a value changes. The sending of the limiting value is implemented when this parameter is set to "Yes".

The limiting value is sent on a change of state from '0' to '1' or from '1' to '0'.

- i If supply voltage monitoring is parametrized and the supply is not available or insufficient, then the limiting value object is fixed to 'Precipitation' and sent twice.

Cyclic sending of the limiting values

All the limiting value objects of the sensors, including those of the precipitation sensor, can be sent cyclically using the parameter 'Cycl. sending of limiting value *n*'. If in the limiting value activation a combination with 'no telegr.' is set, then the corresponding object value is still sent cyclically via the limiting value object when there is a change.

- i Limiting value telegrams 'Sending the limiting value n when value change' that are generated have no effect on the cycle time for the cyclic sending of limiting value objects.

Setting cyclical transmission of a limit value

The sensor for which the limiting value is to be set must be 'Activated' on the parameter page 'General'

On the parameter page of the sensor, for example 'Twilight', the desired 'Limiting value n activated' is set

- On the parameter page "*Measured value* limiting value 1" or "*Measured value* limiting value 2", the parameter "Cyclical sending of the limiting value n " defines the time interval in which the limiting value is to be sent to the bus.

- i The value range to be set is 0 to 120. The value has to be multiplied by 10 seconds to obtain the cycle time.

- i '0' means that the limiting value is not sent cyclically.

The limiting value is sent at the set interval.

4.2.3.7 Delivery state

In the weather station's state as delivered, the application program is unloaded. No feedback is made to the bus. The device can be programmed and put into operation via the ETS. The physical address is preset to 15.15.255

4.2.4 Parameters

4.2.4.1 Parameter group "General"

Description	Values	Comment
☐ General		
Disabling modules	no disabling module 1 disabling module 2 disabling modules 3 disabling modules 4 disabling modules	Select here whether and how many disabling modules should be used. i Disabling modules that are not used will not be displayed in the ETS!
Logic gates	no logic gates 1 logic gate ... 16 logic gates	Select here whether and how many logic gates should be used. i Logic gates that are not used will not be displayed in the ETS!
Shading control	not activated activated	This parameter enables shading control. Additional parameters are enabled. i Sensors that are not activated will not be displayed in the ETS!
Brightness sensor 1	not activated activated	Select here whether you wish to use brightness sensor 1. i Sensors that are not activated will not be displayed in the ETS!
Brightness sensor 2	not activated activated	Select here whether you wish to use brightness sensor 2. i Sensors that are not activated will not be displayed in the ETS!
Brightness sensor 3	not activated activated	Select here whether you wish to use brightness sensor 3. i Sensors that are not activated will not be displayed in the ETS!
Brightness sensor 4	not activated activated	Select here whether you wish to use brightness sensor 4. i Sensors that are not activated will not be displayed in the ETS!
Twilight sensor	not activated activated	Select whether you want to use the twilight sensor here. i Sensors that are not activated will not be displayed in the ETS!
Max. brightness sensors 1 to 4	not activated activated	Activate this parameter if you do not need direction-specific brightness. i If this function is set to "Not activated", it will not be displayed in the ETS!
Max. brightness sensor 1 to 4 and twilight	not activated activated	Activate this parameter if you do not need direction-specific brightness, but you do need increased precision in the lower value range (twilight). When the brightness drops below 1000 lux, the twilight value is output. Because the measuring range of the twilight sensor

		ends at 900 lux, jumps are possible in this range.
		i If this function is set to "Not activated", it will not be displayed in the ETS!
Wind speed	not activated activated	This parameter enables the measurement of the wind speed. Additional parameters are enabled.
		i Sensors that are not activated will not be displayed in the ETS!
Wind direction	not activated activated	This parameter enables the measurement of the wind direction. Additional parameters are enabled.
		i Sensors that are not activated will not be displayed in the ETS!
Precipitation	not activated activated	Select here whether you want to use the precipitation sensor.
		i Sensors that are not activated will not be displayed in the ETS!
Absolute humidity	not activated activated	This parameter enables the measurement of the absolute humidity. Additional parameters are enabled.
		i Sensors that are not activated will not be displayed in the ETS!
Relative humidity	not activated activated	This parameter enables the calculation of the relative humidity. For this parameter to be available, the measurement of the absolute humidity must be enabled. Additional parameters are enabled.
		i Sensors that are not activated will not be displayed in the ETS!
Temperature sensor	not activated activated	Select whether you want to use the temperature sensor here.
		i Sensors that are not activated will not be displayed in the ETS!
Felt temperature	not activated activated	This parameter enables the output of the felt temperature via KNX communication objects. The felt temperature is calculated using an internal method in the weather station. Additional parameters are enabled.
		i Sensors that are not activated will not be displayed in the ETS!
Comfort	not activated activated	This parameter enables the output of comfort and oppressiveness via KNX communication objects. Additional parameters are enabled.
		i Sensors that are not activated will not be displayed in the ETS!
Air pressure	not activated activated	This parameter enables the measurement of the air pressure at the mounting location of the Weather

		station. Additional parameters are enabled.
		i Sensors that are not activated will not be displayed in the ETS!
Global radiation	not activated activated	This parameter enables the measurement of the global radiation. Additional parameters are enabled.
		i Sensors that are not activated will not be displayed in the ETS!
GPS/Glonass	not activated activated	This parameter enables the reception of satellite data. The weather station can then use its GPS receiver to receive both geostationary data as well as the time and date via GPS or Glonass. Additional parameters are enabled.
		i Sensors that are not activated will not be displayed in the ETS!
Monitoring	activated not activated	This parameter enables a parameter page for the project design of monitoring functions of the weather station. Additional parameters are enabled.
		i Functions that are not activated will not be displayed in the ETS!

4.2.4.2 Parameter group "Time"

Description	Values	Comment
☐ Time		
Date/time	Internal clock External clock	This parameter defines whether the weather station uses the internal clock or works with an externally-specified time. If the internal clock is used, then the time is received via the GPS/Glonass signal, irrespective of the "GPS/Glonass" parameter, and sent to the KNX. The communication objects "GPS.Time", "GPS.Date" und "GPS.Send request date/time" are enabled. If the external clock is set, the Weather station requires a valid time and a valid date to be send by a master clock via KNX telegrams. The data and time of the master clock can also be polled actively.

If the date and time are preset externally, then the Weather station will receive the presettings sent from a master clock. Synchronisation between the master clock and the Weather station takes place on the basis of telegrams sent from the master clock. Cyclically sent telegrams increase the accuracy of the internal device clock of the Weather station.

Automatic time setting		This parameter defines whether an automatic time change is to take place, depending on whether the date and time are specified externally or received via GPS/Glonass (internal clock). On the one hand, a change can be implemented according to the European standard. Here, summer time begins on the last Sunday in March and ends on the last Sunday in October. On the other hand, a user-orientated time change can be implemented via a communication object.
	No	External clock: The received values are applied without a change. The time and date must correspond to the time zone. Internal clock: The winter time of the configured time zone is sent to the KNX.
	According to European standard	External clock: The received values are assumed as being winter time. The time and date must correspond to the time zone. Internal clock: The time sent to the KNX corresponds to the configured time zone and the change between summer and winter

		time takes place automatically.
	Via switching object	<p>External clock: The received values are assumed as being winter time. In a "0" logical state, the time and date must correspond to the time zone. As soon as the communication object "GPS. Time change" receives a "1", the receive date and time values are set to summer time.</p> <p>Internal clock: Depending on which logical state the object "GPS. Time change" has, the received time is sent to the KNX as the winter time (state = "0") or summer time (state = "1") of the configured time zone.</p>
Cyclical sending of date/time interval	1/day 1/hour 1/minute	<p>This parameter defines the interval at which the values "GPS.Time" and "GPS.Date" received via GPS/Glonass are sent to the KNX.</p> <p>This parameter is not visible with an external clock!</p>
Send request date/time through	1 telegram 0 telegram	<p>This parameter is only visible if the parameter "Date/time" is set to "Internal clock". It then defines whether a send request for new values (date and time) is triggered via a 1 telegram or a 0 telegram. Note whether the requesting telegram is sent with a "1" or a "0" to the KNX.</p>
Time zone "Internal clock (GPS)"	UTC-12h... UTC+1h... UTC+14h	<p>This parameter is only visible if the parameter "Date/time" is set to "Internal clock". The parameter "Time zone..." defines by how many hours the measured value of the GPS time may deviate from the UTC. For example, UTC+1 hour is Central European Time.</p>
Date / time request through	1 telegram 0 telegram	<p>This parameter is only visible if the parameter "Date/time" is set to "External clock". It then defines whether new values (date and time) are requested via a 1 telegram to the bus or a "0". Note which request the value transmitter reacts to when the date and time are sent.</p>
Request date and time cyclically	1/day 1/hour	<p>This parameter is only visible if the parameter "Date/time" is set to "External clock". It then defines in which cycle the</p>

date and time are requested.

4.2.4.3 Parameter group "Disabling modules"

Description	Values	Comment
<p>☐- Disabling modulen (n = Number of the disabling module / Only visible if at least n modules have been activated in parameter 'Disabling modules' under 'General!')</p>		
Behaviour of disabling object	disabling with 0 telegram	Telegrams with the disabling object value "0" block the disabling module, i.e. changes at the input are not passed on to the output.
	disabling with 1 telegram	Telegrams with the disabling object value "1" block the disabling module, i.e. changes at the input are not passed on to the output.
Disabling response upon initialization	enabled disabled	Parameterise here whether the module is blocked after a bus voltage failure, programming or reset of the device, or whether input telegrams continue to be sent to the output.
Type input/output	Switching - 1-bit Value - 2 bytes Rel. value - 1 byte	Select the object type here (1-bit / 1-byte / 2-byte) that should be switched through.
Input	Internal input value	Depending on the "Type input/output" set, the setting of this parameter has different effects on communication objects and parameters that can be enabled. If this value is selected, a list appears with all of the outputs, error bits and limiting values.
	External input value	An external object (1bit) is assigned to the input
Input	Internal input value	Depending on the "Type input/output" set, the setting of this parameter has different effects on communication objects and parameters that can be enabled. If this value is selected, a list appears with all of the outputs, error bits and limiting values.
	External input value	An external object (2 bytes) is assigned to the input.
Input		Depending on the "Type input/output" set, the setting of this parameter has different effects on communication objects and parameters that can be

enabled.

Internal input value

If this value is selected, a list appears with all of the outputs, error bits and limiting values.

External input value

An external object (1 byte) is assigned to the input.

4.2.4.4 Parameter group "Logic gate"

Description	Values	Comment
<p>☐ Logic gaten (n = number of the logic gate / Only visible if the parameter 'Logic gate n' under 'General' is set to 'Activated!')</p>		
Type of logic operation		Set which logic operation is created by the gate here
	AND	Only if all inputs are "1" will the output be "1"
	OR	If one or more inputs are "1", then the output is "1"
	Exclusive OR	Only if one input is "1" will the output be "1"
	AND with feedback	Only when all the inputs are "1" (AND gate) and the fed back input again receives a "1" will the output be "1"
		<p>i NAND and NOR gates can be implemented by negation of the output</p>
Send output at	Each input event	The output object is sent at each input event. If, for example, a "1" is sent cyclically to an input, then the output state is sent in the same cycle
	Change the output	The output object is sent following a change in the output from "0" to "1" or from "1" to "0".
Number of inputs	1 input 2 inputs 3 inputs 4 inputs	Setting the number of logic gate inputs required.
Behaviour output	normal	If the result of the logic operation is "1", then the output object receives the value "1". If the result of the logic operation is "0", then the output object receives the value "0"
	inverted	If the result of the logic operation is "1", then the output object receives the value "0". If the result of the logic operation is "0", then the output object receives the value "1"
Switch-on delay	No telegram No delay Delay on	A change of the logic operation result from "0" to "1" is not sent A change of the logic operation result from "0" to "1" is sent without a delay. A change of the logic operation result from "0" to "1" is sent with a delay. The

		delay is set using the basis and a factor in the range from 100 milliseconds to 100 minutes.
Switch-on delay Base	100ms 1s 1 min	i Only visible if "Delay on" is parametrized.
Switch-on delay factor	1...100	i Only visible if "Delay on" is parametrized.
Switch-off delay	No telegram No delay Delay on	A change of the logic operation result from "1" to "0" is not sent A change of the logic operation result from "1" to "0" is sent without a delay. A change of the logic operation result from "1" to "0" is only sent after a delay. The delay is set using the basis and a factor in the range from 100 milliseconds to 100 minutes.
Base	100ms 1s 1 min	i Only visible if "Delay on" is parametrized.
Factor	1...100	i Only visible if "Delay on" is parametrized.
Cyclic sending of the output (x 10 s)	0...120	Set here whether and at what time interval the result of the logic operation is sent. The set value multiplied by 10 is the repeat time in seconds. It is thus possible to set the cycle time in step widths of 10 seconds. The value "0" means that no cyclic sending is carried out. i The cyclic telegrams sent via this setting are independent of the telegrams resulting from the setting "Send at".
 ☐ Logic gate n inputs (n = Number of the logic gate / Only visible if at least n gates have been activated in the parameter 'Logic gates' under 'General'!)		
Input 1	Internal input value	This parameter decides whether a list appears with all of the outputs, error bits and limiting values if this value is selected.

	External input value	An external object (1bit) is assigned to the input
Assign input 1		This parameter defines the input value for input 1 of the logic gate. The parameter is only visible if the "Input 1" parameter is set to "internal input value".
Behaviour at the input 1	normal	If the input value is "1", then the value at the input of the logic gate is also "1". If the input value is "0", then the value at the input of the logic gate is also "0".
	inverted	If the input value is "1", then the value at the input of the logic gate is also "0". If the input value is "0", then the value at the input of the logic gate is also "1".
Input n	Internal input value External input value	See comment on parameter "Input 1". i Only visible if input n is activated under "Number of inputs".
Assign n input		See comment on "Assign input 1" parameter. i Only visible if input n is activated under "Number of inputs".
Behaviour at the input n	normal inverted	See comment on "Assign input 1" parameter. i Only visible if input n is activated under "Number of inputs".

4.2.4.5 Parameter group "Shading control"

Description	Values	Comment
<input type="checkbox"/> Shading control (Only visible if the parameter 'Shading control' under 'General' is set to 'Activated!')		
Specification of position and height	not activated activated	This parameter defines whether a shading system receives the position and height of the mounting location of the weather station via data received from GPS or via external specifications. When the parameter is activated, three communication objects and three additional parameters are specified. This parameter is permanently activated when GPS/Glonass is deactivated.
Geographic longitude in °	-180... 0 ...+180	This 4-byte value defines the geographic longitude of the mounting location of the Weather station. The degree of longitude is counted from the zero meridian in the easterly and westerly directions. The positive values up to 180° describe the position in an easterly direction and the negative values up to -180° the position in a westerly direction. This parameter is only visible, if the parameter "Specification of position and height" was set to "Active".
Geographic latitude in °	-90... 0 ...+90	This 4-byte value defines the geographic longitude of the mounting location of the Weather station. The latitude is counted in a northerly and southerly direction from the Equator. The positive values up to 90° describe the position in a northerly direction and the negative values up to -90° the position in a southerly direction. This parameter is only visible, if the parameter "Specification of position and height" was set to "Active".
geographical height in meters above mean sea level	0... 250 ...8848	This 2-byte value defines the geographic height of the mounting location of the weather station. This parameter is only visible, if the parameter "Specification of position and height" was set to "Active".
Basic brightness threshold	Internal External	This parameter is used to decide whether the basic brightness threshold is preset internally via an additional parameter or externally via a communication object.

Basic brightness for shading in kLux	3... 10 ...50	This parameter defines the threshold value of the basic value if the parameter "Basic brightness threshold" is set to "Internal". The value entered here, multiplied by 1000, produces the threshold value in Lux.
Hysteresis basic brightness in kLux	1... 3 ...30	The hysteresis of the threshold value for basic brightness is defined using this parameter. The communication objects "Shading facade 1...8" are used to send a signal that the threshold value has been exceeded using a 1-bit command when the configured threshold value plus the hysteresis value has been exceeded. The value entered here, multiplied by 1000, produces the hysteresis value in Lux.
Cyclical sending of the shading objects	Do not send cyclically 5 min cycle 10 min cycle 15 min cycle 20 min cycle 25 min cycle 30 min cycle 35 min cycle 40 min cycle	If required, the weather station can send the telegrams of the shading objects cyclically. This parameter defines the interval at which the measured values are sent.
Switch-on delay, basic brightness	No delay 1 min delay 3 min delay 5 min delay 10 min delay 15 min delay 30 min delay 60 min delay	This parameter can be used to set a switch-on delay according to the basic brightness. The automatic shading control is only activated after the configured time delay has elapsed and the basic brightness threshold value is still exceeded. No delay means immediate activation of the automatic shading control.
Switch-off delay, Switch-off delay, basic brightness	No delay 1 min delay 3 min delay 5 min delay 10 min delay 15 min delay 30 min delay 60 min delay	This parameter can be used to set a switch-off delay according to the basic brightness. The automatic shading control is only deactivated after the configured time delay has elapsed and the basic brightness threshold value has still been fallen below. No delay means immediate deactivation of the automatic shading control.
Format of the shading objects	1-bit 1-byte (position)	This parameter defines the format of the shading objects. Depending on the selected format, the appropriate communication object is connected via group addresses with the "Long-time

		operation" objects for the "1-bit" format or with the "Positioning" objects for the "1-byte" format.
Waiting time between shading and slat position	No waiting time 1 min waiting time 2 min waiting time 3 min waiting time 4 min waiting time 5 min waiting time 6 min waiting time 7 min waiting time 8 min waiting time 9 min waiting time 10 min waiting time	The value selected here is the waiting time which elapses after sending via the object "Shading, facade 1...8" until the value of the slat position is sent. This ensures that the blind/shutter has reached the lowest position and is thus ready for slat adjustment. The slat position to be adjusted to is then sent.
Cyclical sending of the slat position	0...255	The value set here defines the cycle time in minutes after which the slat position is sent to the bus.
Send slat position on	1° elevation change 3° elevation change 5° elevation change 10° elevation change 15° elevation change	The entry selected here specifies the value by which the elevation angle must at least change for the slat position to be resent to the bus.
Send blind/shutter height after end of the shading	No Yes	This parameter defines whether the blind/shutter height is sent after the end of shading.
Send slat position after end of the shading	No Yes	This parameter defines whether the slat position is sent after the end of shading.
Number of facades	1...4...8	This parameter defines the number of facades integrated in the shading control. A maximum of 8 facades can be moved. An additional parameter page is enabled for each facade.
<input type="checkbox"/> Facade n (Only visible for the number of facades enabled under the parameter 'Number of facades' under 'Shading control!')		
Orientation of the facade in °	0...360	This parameter defines the orientation of the facade from 0° to 360°. 0°/360° = North 45° = North-East 90° = East 135° = South-East 180° = South 225° = South-West 270° = West 315° = North-West

Opening angle to the sun	Internal External	This parameter decides whether the opening angle of the facade to the sun is configured internally using a parameter or if it is preset and changed externally using a 1-byte object.
Opening angle in °	0... 150 ...180	This parameter defines the opening angle of the facade from 0° to 180°. The opening angle determines in which area the sun's azimuth is located for an interfering glare to occur. The parameter is only shown when the parameter "Opening angle to the sun" is preset internally. When should the shading function be triggered for this function? 0°: No shading 1°: When the sun is shining almost vertically on the facade. 150°: When the sun is shining on the facade at an angle of more than 15°. 179°: As soon as the sun is only minimally shining on the facade.
Slat position for min. shading in %	0... 50 ...100	This parameter defines the setting for fully opened slats.
Slat position for max. shading in %	0... 100	This parameter defines the setting for the fully-closed slat position.
Offset slat position in %	0 ...100	This parameter can be used to adjust the position of the slat to the sun's elevation. The preset value "0" corresponds to a slat alignment at an angle of 90° to the sun.
Type of blind/shutter object	1-bit 1-byte (position)	Depending on the object type, either the sun protection of Venetian blind position objects of the Venetian blind actuators can be activated. When the 1-bit objects are used, the blind/shutter heights of the various thresholds must be saved in the actuators. When the 1-byte objects are used, the weather station sends the blind/shutter positions defined for the elevation.
Activate threshold <i>n</i>	No Yes	This parameter renders the objects and parameters for the threshold visible or invisible.

Sun position angle threshold n in °	0... 15 ...90	Sun position angle (elevation), from which the threshold 1 object assumes the value 1 for this facade.
Blind/shutter height threshold n in %	0... 80 ...100	Value sent via the blind/shutter height threshold / position object of this facade when the sun position angle (previous parameter) is exceeded.
Disable facade control	No Yes	This parameter renders the objects and parameters for the disabling function of this facade visible (Yes) or invisible (No).
Polarity of disable object	Locking when 1-telegram Locking when 0-telegram	This parameter presets the object value at which automatic shading control of this facade is disabled.
Behaviour at the beginning of the disabling function	No action Send configured state	If the disabling function is to be used for facade control, then the additional parameters can define the reactions to a value change in the disabling object. The possible settings depend on the selected types of the objects for blind/shutter height and shading.
Behaviour at the end of the disabling function	No action Send configured state	If the disabling function is to be used for facade control, then the additional parameters can define the reactions to a value change in the disabling object. The possible settings depend on the selected types of the objects for blind/shutter height and shading.
If the parameter "Type of blind/shutter object" = 1-byte and Behaviour at the beginning of the disabling function = Send configured state		
Blind/shutter height	No action Send blind/shutter height	Behaviour of the object of this facade on starting disabling. No action: The object is only sent on the next change. Send blind/shutter height: The value of the following parameter is sent.
Blind/shutter height value (%)	0 ... 100	This parameter defines the value of the blind/shutter height in percent.

If the parameter "Format of shading objects" = 1-bit and
Behaviour at the beginning of the disabling function = Send configured state

Shading object	No action Send shading object	Behaviour of the object of this facade on starting disabling. No action: The object is only sent on the next change. Send shading object: The value of the following parameter is sent.
----------------	---	---

Shading bit value	0 1	This parameter defines the value of the shading bit.
-------------------	---------------	--

If the parameter "Format of shading objects" = 1-byte and
Behaviour at the beginning of the disabling function = Send configured state

Shading object	No action Send shading object	Behaviour of the object of this facade on starting disabling. No action: The object is only sent on the next change. Send shading object: The value of the following parameter is sent.
----------------	---	---

Value of shading byte (%)	0 ... 100	This parameter defines the value of the shading byte in percent.
---------------------------	------------------	--

If behaviour at the beginning of the disabling function = Send configured state

Slat position	No action Send slat position	Behaviour of the object of this facade on starting disabling. No action: The object is only sent on the next change. Send slat position: The value of the following parameter is sent.
---------------	--	--

Slat position value (%)	0 ... 100	This parameter defines the value of the slat position in percent.
-------------------------	------------------	---

If type of blind/shutter height object = 1-byte and
Behaviour at the end of the disabling function = Send configured state

Blind/shutter height	No action Send blind/shutter height Track	Behaviour of the object of this facade on starting disabling. Send blind/shutter height: The value of the following parameter is sent. Track: Current object value is sent.
----------------------	--	---

Blind/shutter height value (%)	0 ... 100	This parameter defines the value of the blind/shutter height in percent.
--------------------------------	------------------	--

If the parameter "Format of shading objects" = 1-bit and
Behaviour at the end of the disabling function = Send configured state

Shading object	No action Send shading object Track	Behaviour of the object of this facade on starting disabling. Send shading object: The value of the following parameter is sent. Track: Current object value is sent.
----------------	--	---

Shading bit value	0 1	This parameter defines the value of the shading bit.
-------------------	---------------	--

If the parameter "Format of shading objects" = 1-byte and
Behaviour at the end of the disabling function = Send configured state

Shading object	No action Send shading object Track	Behaviour of the object of this facade on starting disabling. Send shading object: The value of the following parameter is sent. Track: Current object value is sent.
----------------	--	---

Value of shading byte (%)	0 ... 100	This parameter defines the value of the shading byte in percent.
---------------------------	------------------	--

If behaviour at the end of the disabling function = Send configured state

Slat position	No action Send slat position Track	Behaviour of the object of this facade on starting disabling. Send slat position: The value of the following parameter is sent. Track: Current object value is sent.
---------------	---	--

Slat position value (%)	0 ... 100	This parameter defines the value of the slat position in percent.
-------------------------	------------------	---

4.2.4.6 Parameter group "Brightness sensor"

Description	Values	Comment
<input type="checkbox"/> Brightness sensor n (n = Number of the sensor / Only visible if the parameter 'Brightness sensor n ' under 'General' is set to 'Activated!') (Measuring range 0...150,000 Lux)		
Limiting values	not activated Limiting value 1 activated Limiting values 1 and 2 activated	Select here whether this sensor should have limiting values, and how many. <input type="checkbox"/> Limiting values that are not activated will not be displayed!
Send measured value on (10 s send delay)	0.5% measured value difference 1% measured value difference 3% measured value difference 10% measured value difference	So as not to burden the bus with very frequent telegrams, the measured value should not be sent for every tiny change. While taking the measurement task into account, a maximum possible value should be set here. <input type="checkbox"/> The percentage specification for the measured value difference is always relative to the measuring range upper range value! <input type="checkbox"/> A fixed sending delay of 10 seconds is set.
Cycl. sending of the measured value (x 10 s)	0...120	Set here whether and at what time interval the value is sent. The set value multiplied by 10 is the repeat time in seconds. It is thus possible to set the cycle time in step widths of 10 seconds. The value "0" means that no cyclic sending is carried out. <input type="checkbox"/> The cyclic telegrams sent via this setting are independent of the telegrams resulting from the setting "Send measured value on... measured value difference".
<input type="checkbox"/> Brightness sensor n limiting value 1 (n = Number of the sensor / Only visible if the parameter 'Brightness sensor n ' under 'General' is set to 'Activated' and the parameter 'Limiting values' is set to 'Limiting value 1 activated' or 'Limiting values 1 and 2 activated!')		
Limiting value 1 in klx	3 kLux 5 kLux 10 kLux 15 kLux 20 kLux 25 kLux 30 kLux 35 kLux 40 kLux 45 kLux 50 kLux 55 kLux 60 kLux 65 kLux 70 kLux 75 kLux 80 kLux 85 kLux	Set here the threshold for the limiting value in the range from 3 klx to 105 klx. <input type="checkbox"/> In conjunction with the parameters "Limiting value 1" and "Hysteresis limiting value 1", define the thresholds at which the limiting value object is set to "1" or "0" when they are exceeded or undershot.

	90 kLux 95 kLux 100 kLux 105 kLux	
Hysteresis limiting value 1 in klx	No hysteresis 1 kLux 2 kLux 3 kLux 4 kLux 5 kLux 10 kLux 20 kLux 30 kLux 40 kLux 50 kLux 60 kLux 70 kLux 80 kLux 90 kLux 100 kLux	Set here the hysteresis in the range from no hysteresis to 100 klx. i In conjunction with the parameters "Limiting value 1" and "Hysteresis limiting value 1", define the thresholds at which the limiting value object is set to "1" or "0" when they are exceeded or undershot.
Activation of limiting value 1 LV=Limiting value, Hyst.=Hysteresis	Exceed LV = ON, Undershoot LV - hyst. = OFF Exceed LV = OFF, Undershoot LV - hyst. = ON Undershoot LV = ON, Exceed LV + hyst. = OFF Undershoot LV = OFF, Exceed LV + hyst. = ON Exceed LV = ON, Undershoot LV hyst. = No telegr. Exceed LV = OFF, Undershoot LV hyst. = No telegr. Undershoot LV = ON, Exceed LV + hyst. = No telegr. Undershoot LV = OFF, Exceed LV + hyst. = No telegr. Exceed LV = No telegr., Undershoot LV hyst. = OFF Exceed LV = No telegr., Undershoot LV hyst. = ON Undershoot LV = No telegr., Exceed LV + hyst. = OFF Undershoot LV =	Here, it is possible to set which action is to be executed when the limiting value is crossed from an exactly defined direction. i In conjunction with the parameters "Limiting value 1" and "Hysteresis limiting value 1", define the thresholds at which the limiting value object is set to "1" or "0" when they are exceeded or undershot.

	No telegr., Exceed LV + hyst. = ON	
External limiting value 1	No	No external limiting value 1 is parametrized
	16 bit value	The limiting value is specified by an external device using a 2-byte value object.
	8 bit value	The limiting value is specified by an external device using a 1-byte value object.
	Save limiting value via switching obj. (teaching)	When this external switching object is used, the current measured value of the sensor can be defined as limiting value, e.g. by a button-press.
		<ul style="list-style-type: none"> i Using an external object, the user of the building can set the limiting value to suit their needs, without having to change the configuration. i During a download, the external values are overwritten with the ETS data. Only when a value is again received after a download is this value processed again.
Switch-on delay limiting value 1	No delay 1s delay 3s delay 5s delay 10s delay 15s delay 30s delay 1min delay 3min delay 5min delay 10min delay 15min delay 30min delay 60min delay	Only after the time set here will the current state of the limiting value be accepted in the limiting value object. This means that <ul style="list-style-type: none"> - a change in the limiting value to "1" will only be sent after this time elapses, - in the case of cyclic sending of the limiting value, the changed value "1" is only sent after this time expires. Therefore a "0" continues to be sent while the timer for the delay time is running. <ul style="list-style-type: none"> i If the parameter "Activation limiting value" for a condition is set to "No telegram", then the cyclic telegrams are also suppressed when the set condition is fulfilled.
Switch-off delay limiting value 1	No delay 1s delay 3s delay 5s delay 10s delay 15s delay 30s delay 1min delay 3min delay 5min delay 10min delay 15min delay 30min delay 60min delay	Only after the time set here will the current state of the limiting value be accepted in the limiting value object. This means that <ul style="list-style-type: none"> - a change in the limiting value to "0" will only be sent after this time elapses, - in the case of cyclic sending of the limiting value, the changed value "0" is only sent after this time expires. Therefore a "1" continues to be sent while the timer for the delay time is running. <ul style="list-style-type: none"> i If the parameter "Activation limiting value" for a condition is set to "No telegram", then the cyclic telegrams are also suppressed when the set condition is fulfilled.

Sending of limiting value 1 for value change	No	The limiting value object is not sent following a change. If the parameter "Cyclic sending of the limiting value" is set to at least 1, then the limiting value object is sent cyclically regardless of any change.
	Yes	The limiting value object is sent following a change from "0" to "1" or from "1" to "0". i If this parameter "Sending of limiting value for value change" is set to "No" and the parameter "Cyclic sending of the limiting value" is set to "0", then the limiting value is not sent at all.
Cycl. Sending of limiting value 1 (x 10 s)	0...120	Set whether and at what time interval the limiting value is sent here. The set value multiplied by 10 is the repeat time in seconds. It is thus possible to set the cycle time in step widths of 10 seconds. The value "0" indicates that the limiting value object is not transmitted cyclically. i If this parameter "Sending of limiting value for value change" is set to "No" and the parameter "Cyclic sending of the limiting value" is set to "0", then the limiting value is not sent at all.
□- Brightness sensor n limiting value 2 (n = Number of the sensor / Only visible if the parameter 'Brightness sensor n' under 'General' is set to 'Activated' and the parameter 'Limiting values' is set to 'Limiting values 1 and 2 activated'!)		
Limiting value 2 in klx	3 kLux 5 kLux 10 kLux 15 kLux 20 kLux 25 kLux 30 kLux 35 kLux 40 kLux 45 kLux 50 kLux 55 kLux 60 kLux 65 kLux 70 kLux 75 kLux 80 kLux 85 kLux 90 kLux 95 kLux 100 kLux 105 kLux	Set here the threshold for the limiting value in the range from 3 klx to 105 klx. i In conjunction with the parameters "Limiting value 2" and "Hysteresis limiting value 2", define the thresholds at which the limiting value object is set to "1" or "0" when they are exceeded or undershot.
Hysteresis limiting value 2 in klx	No hysteresis 1 kLux 2 kLux 3 kLux 4 kLux	Set here the hysteresis in the range from no hysteresis to 100 klx.

	<p>5 kLux 10 kLux 20 kLux 30 kLux 40 kLux 50 kLux 60 kLux 70 kLux 80 kLux 90 kLux 100 kLux</p>	<p>i In conjunction with the parameters "Limiting value 2" and "Hysteresis limiting value 2", define the thresholds at which the limiting value object is set to "1" or "0" when they are exceeded or undershot.</p>
<p>Activation of limiting value 2 LV=Limiting value, Hyst.=Hysteresis</p>	<p>Exceed LV = ON, Undershoot LV - hyst. = OFF</p> <p>Exceed LV = OFF, Undershoot LV - hyst. = ON</p> <p>Undershoot LV = ON, Exceed LV + hyst. = OFF</p> <p>Undershoot LV = OFF, Exceed LV + hyst. = ON</p> <p>Exceed LV = ON, Undershoot LV hyst. = No telegr.</p> <p>Exceed LV = OFF, Undershoot LV hyst. = No telegr.</p> <p>Undershoot LV = ON, Exceed LV + hyst. = No telegr.</p> <p>Undershoot LV = OFF, Exceed LV + hyst. = No telegr.</p> <p>Exceed LV = No telegr., Undershoot LV hyst. = OFF</p> <p>Exceed LV = No telegr., Undershoot LV hyst. = ON</p> <p>Undershoot LV = No telegr., Exceed LV + hyst. = OFF</p> <p>Undershoot LV = No telegr., Exceed LV + hyst. = ON</p>	<p>Here, it is possible to set which action is to be executed when the limiting value is crossed from an exactly defined direction.</p> <p>i In conjunction with the parameters "Limiting value 2" and "Hysteresis limiting value 2", define the thresholds at which the limiting value object is set to "1" or "0" when they are exceeded or undershot.</p>
<p>External limiting value 2</p>	<p>No</p> <p>16 bit value</p> <p>8 bit value</p>	<p>No external limiting value 2 is parametrized</p> <p>The limiting value is specified by an external device using a 2-byte value object.</p>

	Save limiting value via switching obj. (teaching)	The limiting value is specified by an external device using a 1-byte value object.
Switch-on delay limiting value 2	No delay 1s delay 3s delay 5s delay 10s delay 15s delay 30s delay 1min delay 3min delay 5min delay 10min delay 15min delay 30min delay 60min delay	<p>When this external switching object is used, the current measured value of the sensor can be defined as limiting value, e.g. by a button-press.</p> <ul style="list-style-type: none"> i Using an external object, the user of the building can set the limiting value to suit their needs, without having to change the configuration. i During a download, the external values are overwritten with the ETS data. Only when a value is again received after a download is this value processed again. <p>Only after the time set here will the current state of the limiting value be accepted in the limiting value object. This means that</p> <ul style="list-style-type: none"> - a change in the limiting value to "1" will only be sent after this time elapses, - in the case of cyclic sending of the limiting value, the changed value "1" is only sent after this time expires. <p>Therefore a "0" continues to be sent while the timer for the delay time is running.</p> <ul style="list-style-type: none"> i If the parameter "Activation limiting value" for a condition is set to "No telegram", then the cyclic telegrams are also suppressed when the set condition is fulfilled.
Switch-off delay limiting value 2	No delay 1s delay 3s delay 5s delay 10s delay 15s delay 30s delay 1min delay 3min delay 5min delay 10min delay 15min delay 30min delay 60min delay	<p>Only after the time set here will the current state of the limiting value be accepted in the limiting value object. This means that</p> <ul style="list-style-type: none"> - a change in the limiting value to "0" will only be sent after this time elapses, - in the case of cyclic sending of the limiting value, the changed value "0" is only sent after this time expires. <p>Therefore a "1" continues to be sent while the timer for the delay time is running.</p> <ul style="list-style-type: none"> i If the parameter "Activation limiting value" for a condition is set to "No telegram", then the cyclic telegrams are also suppressed when the set condition is fulfilled.
Sending of limiting value 2 for value change	No	<p>The limiting value object is not sent following a change.</p> <p>If the parameter "Cyclic sending of the limiting value" is set to at least 1, then the limiting value object is sent cyclically regardless of any change.</p>
	Yes	

Cycl. Sending of limiting value 1
(x 10 s) 0...120

The limiting value object is sent following a change from "0" to "1" or from "1" to "0".

i If this parameter "Sending of limiting value for value change" is set to "No" and the parameter "Cyclic sending of the limiting value" is set to "0", then the limiting value is not sent at all.

Set whether and at what time interval the limiting value is sent here. The set value multiplied by 10 is the repeat time in seconds. It is thus possible to set the cycle time in step widths of 10 seconds. The value "0" indicates that the limiting value object is not transmitted cyclically.

i If this parameter "Sending of limiting value for value change" is set to "No" and the parameter "Cyclic sending of the limiting value" is set to "0", then the limiting value is not sent at all.

☐ "Max. brightness sensor 1 to 4" and "Max. brightness sensor 1 to 4 and twilight"

Parameters see brightness sensor *n*

4.2.4.7 Parameter group "Twilight sensor"

Description	Values	Comment
<input type="checkbox"/> Twilight (Only visible if the parameter 'Twilight' under 'General' is set to 'Activated') (Measuring range 0...900 Lux)		
Limiting values	not activated Limiting value 1 activated Limiting values 1 and 2 activated	Select here whether this sensor should have limiting values, and how many. <input type="checkbox"/> Limiting values that are not activated will not be displayed!
Send measured value on (10 s send delay)	0.5% measured value difference 1% measured value difference 3% measured value difference 10% measured value difference	So as not to burden the bus with very frequent telegrams, the measured value should not be sent for every tiny change. While taking the measurement task into account, a maximum possible value should be set here. <input type="checkbox"/> The percentage specification for the measured value difference is always relative to the measuring range upper range value! <input type="checkbox"/> A fixed sending delay of 10 seconds is set.
Cycl. sending of the measured value (x 10 s)	0...120	Set here whether and at what time interval the value is sent. The set value multiplied by 10 is the repeat time in seconds. It is thus possible to set the cycle time in step widths of 10 seconds. The value "0" means that no cyclic sending is carried out. <input type="checkbox"/> The cyclic telegrams sent via this setting are independent of the telegrams resulting from the setting "Send measured value on... measured value difference".
<input type="checkbox"/> Twilight limiting value 1 (Only visible if the parameter 'Twilight' under 'General' is set to 'Activated' and the parameter 'Limiting values' is set here to 'Limiting value 1 activated' or to 'Limiting values 1 and 2 activated')		
Limiting value 1 in lux	10 lux 25 lux 50 lux 75 lux 100 lux 125 lux 150 lux 175 lux 200 lux 225 lux 250 lux 275 lux 300 lux 325 lux 350 lux 375 lux 400 lux 425 lux 450 lux	Set here the threshold for the limiting value in the range from 10 lux to 650 lux. <input type="checkbox"/> In conjunction with the parameters "Limiting value 1" and "Hysteresis limiting value 1", define the thresholds at which the limiting value object is set to "1" or "0" when they are exceeded or undershot.

	475 lux 500 lux 525 lux 550 lux 575 lux 600 lux 625 lux 650 lux	
Hysteresis limiting value 1 in lux	No hysteresis 5 lux 10 lux 25 lux 50 lux 100 lux 150 lux 200 lux 250 lux 300 lux 350 lux 400 lux 450 lux 500 lux 550 lux 600 lux	Set here the hysteresis in the range from no hysteresis to 600 lux. i In conjunction with the parameters "Limiting value 1" and "Activation of limiting value 1", define the thresholds at which the limiting value object is set to "1" or "0" when they are exceeded or fallen below.
Activation of limiting value 1 LV=Limiting value, Hyst.=Hysteresis	Exceed LV = ON, Undershoot LV - hyst. = OFF Exceed LV = OFF, Undershoot LV - hyst. = ON Undershoot LV = ON, Exceed LV + hyst. = OFF Undershoot LV = OFF, Exceed LV + hyst. = ON Exceed LV = ON, Undershoot LV hyst. = No telegr. Exceed LV = OFF, Undershoot LV hyst. = No telegr. Undershoot LV = ON, Exceed LV + hyst. = No telegr. Undershoot LV = OFF, Exceed LV + hyst. = No telegr. Exceed LV = No telegr., Undershoot LV hyst. = OFF Exceed LV = No telegr., Undershoot LV hyst. = ON Undershoot LV =	Here, it is possible to set which action is to be executed when the limiting value is crossed from an exactly defined direction. i In conjunction with the parameters "Limiting value 1" and "Hysteresis limiting value 1", define the thresholds at which the limiting value object is set to "1" or "0" when they are exceeded or undershot.

	No telegr., Exceed LV + hyst. = OFF	
	Undershoot LV = No telegr., Exceed LV + hyst. = ON	
External limiting value 1	No	No external limiting value 1 is parametrized
	16 bit value	The limiting value is specified by an external device using a 2-byte value object.
	8 bit value	The limiting value is specified by an external device using a 1-byte value object.
	Save limiting value via switching obj. (teaching)	When this external switching object is used, the current measured value of the sensor can be defined as limiting value, e.g. by a button-press.
		<ul style="list-style-type: none"> i Using an external object, the user of the building can set the limiting value to suit their needs, without having to change the configuration. i During a download, the external values are overwritten with the ETS data. Only when a value is again received after a download is this value processed again.
Switch-on delay limiting value 1	No delay 1s delay 3s delay 5s delay 10s delay 15s delay 30s delay 1min delay 3min delay 5min delay 10min delay 15min delay 30min delay 60min delay	<p>Only after the time set here will the current state of the limiting value be accepted in the limiting value object. This means that</p> <ul style="list-style-type: none"> - a change in the limiting value to "1" will only be sent after this time elapses, - in the case of cyclic sending of the limiting value, the changed value "1" is only sent after this time expires. <p>Therefore a "0" continues to be sent while the timer for the delay time is running.</p> <ul style="list-style-type: none"> i If the parameter "Activation limiting value" for a condition is set to "No telegram", then the cyclic telegrams are also suppressed when the set condition is fulfilled.
Switch-off delay limiting value 1	No delay 1s delay 3s delay 5s delay 10s delay 15s delay 30s delay 1min delay 3min delay 5min delay 10min delay 15min delay 30min delay 60min delay	<p>Only after the time set here will the current state of the limiting value be accepted in the limiting value object. This means that</p> <ul style="list-style-type: none"> - a change in the limiting value to "0" will only be sent after this time elapses, - in the case of cyclic sending of the limiting value, the changed value "0" is only sent after this time expires. <p>Therefore a "1" continues to be sent while the timer for the delay time is running.</p>

Sending of limiting value 1 for value change	No	<p>i If the parameter "Activation limiting value" for a condition is set to "No telegram", then the cyclic telegrams are also suppressed when the set condition is fulfilled.</p> <p>The limiting value object is not sent following a change. If the parameter "Cyclic sending of the limiting value" is set to at least 1, then the limiting value object is sent cyclically regardless of any change.</p>
	Yes	<p>The limiting value object is sent following a change from "0" to "1" or from "1" to "0".</p> <p>i If this parameter "Sending of limiting value for value change" is set to "No" and the parameter "Cyclic sending of the limiting value" is set to "0", then the limiting value is not sent at all.</p>
Cycl. Sending of limiting value 1 (x 10 s)	0...120	<p>Set whether and at what time interval the limiting value is sent here. The set value multiplied by 10 is the repeat time in seconds. It is thus possible to set the cycle time in step widths of 10 seconds. The value "0" indicates that the limiting value object is not transmitted cyclically.</p> <p>i If this parameter "Sending of limiting value for value change" is set to "No" and the parameter "Cyclic sending of the limiting value" is set to "0", then the limiting value is not sent at all.</p>
<p><input type="checkbox"/> Twilight limiting value 2 (Only visible if the parameter 'Twilight' under 'General' is set to 'Activated' and the parameter 'Limiting values' is set here to 'Limiting values 1 and 2 activated!')</p>		
Limiting value 2 in lux	10 lux 25 lux 50 lux 75 lux 100 lux 125 lux 150 lux 175 lux 200 lux 225 lux 250 lux 275 lux 300 lux 325 lux 350 lux 375 lux 400 lux 425 lux 450 lux 475 lux 500 lux 525 lux 550 lux	<p>Set here the threshold for the limiting value in the range from 1 lux to 650 lux.</p> <p>i In conjunction with the parameters "Limiting value 2" and "Hysteresis limiting value 2", define the thresholds at which the limiting value object is set to "1" or "0" when they are exceeded or undershot.</p>

	575 lux 600 lux 625 lux 650 lux	
Hysteresis limiting value 2 in lux	No hysteresis 5 lux 10 lux 25 lux 50 lux 100 lux 150 lux 200 lux 250 lux 300 lux 350 lux 400 lux 450 lux 500 lux 550 lux 600 lux	Set here the hysteresis in the range from no hysteresis to 600 lux. i In conjunction with the parameters "Limiting value 2" and "Activation of limiting value 2", define the thresholds at which the limiting value object is set to "1" or "0" when they are exceeded or fallen below.
Activation of limiting value 2 LV=Limiting value, Hyst.=Hysteresis	Exceed LV = ON, Undershoot LV - hyst. = OFF Exceed LV = OFF, Undershoot LV - hyst. = ON Undershoot LV = ON, Exceed LV + hyst. = OFF Undershoot LV = OFF, Exceed LV + hyst. = ON Exceed LV = ON, Undershoot LV hyst. = No telegr. Exceed LV = OFF, Undershoot LV hyst. = No telegr. Undershoot LV = ON, Exceed LV + hyst. = No telegr. Undershoot LV = OFF, Exceed LV + hyst. = No telegr. Exceed LV = No telegr., Undershoot LV hyst. = OFF Exceed LV = No telegr., Undershoot LV hyst. = ON Undershoot LV = No telegr., Exceed LV + hyst. = OFF Undershoot LV =	Here, it is possible to set which action is to be executed when the limiting value is crossed from an exactly defined direction. i In conjunction with the parameters "Limiting value 2" and "Hysteresis limiting value 2", define the thresholds at which the limiting value object is set to "1" or "0" when they are exceeded or undershot.

	No telegr., Exceed LV + hyst. = ON	
External limiting value 2	No	No external limiting value 2 is parametrized
	16 bit value	The limiting value is specified by an external device using a 2-byte value object.
	8 bit value	The limiting value is specified by an external device using a 1-byte value object.
	Save limiting value via switching obj. (teaching)	When this external switching object is used, the current measured value of the sensor can be defined as limiting value, e.g. by a button-press.
		<ul style="list-style-type: none"> i Using an external object, the user of the building can set the limiting value to suit their needs, without having to change the configuration. i During a download, the external values are overwritten with the ETS data. Only when a value is again received after a download is this value processed again.
Switch-on delay limiting value 2	No delay 1s delay 3s delay 5s delay 10s delay 15s delay 30s delay 1min delay 3min delay 5min delay 10min delay 15min delay 30min delay 60min delay	<p>Only after the time set here will the current state of the limiting value be accepted in the limiting value object. This means that</p> <ul style="list-style-type: none"> - a change in the limiting value to "1" will only be sent after this time elapses, - in the case of cyclic sending of the limiting value, the changed value "1" is only sent after this time expires. <p>Therefore a "0" continues to be sent while the timer for the delay time is running.</p> <ul style="list-style-type: none"> i If the parameter "Activation limiting value" for a condition is set to "No telegram", then the cyclic telegrams are also suppressed when the set condition is fulfilled.
Switch-off delay limiting value 2	No delay 1s delay 3s delay 5s delay 10s delay 15s delay 30s delay 1min delay 3min delay 5min delay 10min delay 15min delay 30min delay 60min delay	<p>Only after the time set here will the current state of the limiting value be accepted in the limiting value object. This means that</p> <ul style="list-style-type: none"> - a change in the limiting value to "0" will only be sent after this time elapses, - in the case of cyclic sending of the limiting value, the changed value "0" is only sent after this time expires. <p>Therefore a "1" continues to be sent while the timer for the delay time is running.</p> <ul style="list-style-type: none"> i If the parameter "Activation limiting value" for a condition is set to "No telegram", then the cyclic telegrams are also suppressed when the set condition is fulfilled.

Sending of limiting value 2 for value change	No	The limiting value object is not sent following a change. If the parameter "Cyclic sending of the limiting value" is set to at least 1, then the limiting value object is sent cyclically regardless of any change.
	Yes	<p>The limiting value object is sent following a change from "0" to "1" or from "1" to "0".</p> <p>i If this parameter "Sending of limiting value for value change" is set to "No" and the parameter "Cyclic sending of the limiting value" is set to "0", then the limiting value is not sent at all.</p>
Cycl. Sending of limiting value 2 (x 10 s)	0...120	<p>Set whether and at what time interval the limiting value is sent here. The set value multiplied by 10 is the repeat time in seconds. It is thus possible to set the cycle time in step widths of 10 seconds. The value "0" indicates that the limiting value object is not transmitted cyclically.</p> <p>i If this parameter "Sending of limiting value for value change" is set to "No" and the parameter "Cyclic sending of the limiting value" is set to "0", then the limiting value is not sent at all.</p>

☐ "Max. brightness sensor 1 to 4" and "Max. brightness sensor 1 to 4 and twilight"

Parameters see brightness sensor *n*

4.2.4.8 Parameter group "Wind speed"

Description	Values	Comment
<input type="checkbox"/> Wind speed (Only visible if the parameter 'Wind speed' under 'General' is set to 'Activated!') (Measuring range 1...30 m/s)		
Limiting values	not activated Limiting value 1 activated Limiting values 1 and 2 activated	Select here whether this sensor should have limiting values, and how many. i Limiting values that are not activated will not be displayed!
Send measured value on (10 s send delay)	0.5% measured value difference 1% measured value difference 3% measured value difference 10% measured value difference	So as not to burden the bus with very frequent telegrams, the measured value should not be sent for every tiny change. While taking the measurement task into account, a maximum possible value should be set here. i The percentage specification for the measured value difference is always relative to the measuring range upper range value! i A fixed sending delay of 10 seconds is set.
Cycl. sending of the measured value (x 10 s)	0...120	Set here whether and at what time interval the value is sent. The set value multiplied by 10 is the repeat time in seconds. It is thus possible to set the cycle time in step widths of 10 seconds. The value "0" means that no cyclic sending is carried out. i The cyclic telegrams sent via this setting are independent of the telegrams resulting from the setting "Send measured value on... measured value difference".
<input type="checkbox"/> Wind speed limiting value 1 (Only visible if the parameter 'Wind speed' under 'General' is set to 'Activated' and the parameter 'Limiting values' is set here to 'Limiting value 1 activated' or to 'Limiting values 1 and 2 activated!')		
Limiting value 1 in m/s	1 m/s (wind speed 1) 3 m/s (wind speed 2) 5 m/s (wind speed 3) 8 m/s (wind speed 4) 10 m/s (wind speed 5) 12 m/s (wind speed 6) 15 m/s (wind speed 7) 20 m/s (wind speed 8) 22 m/s (wind speed 9) 25 m/s (wind speed 10) 30 m/s (wind speed 11) 35 m/s (wind speed 12)	Set the threshold for the limiting value in the range from 1 m/s to 35 m/s here. i In conjunction with the parameters "Limiting value 1" and "Hysteresis limiting value 1", define the thresholds at which the limiting value object is set to "1" or "0" when they are exceeded or undershot.
Hysteresis limiting value 1 in m/s	1 m/s 3 m/s 5 m/s 8 m/s 10 m/s	Set here the hysteresis in the range from no hysteresis to 10 m/s.

Activation of limiting value 1
LV=Limiting value,
Hyst.=Hysteresis

**Exceed LV = ON,
Undershoot LV - hyst. = OFF**

Exceed LV = OFF,
Undershoot LV - hyst. = ON

Undershoot LV = ON,
Exceed LV + hyst. = OFF

Undershoot LV = OFF,
Exceed LV + hyst. = ON

Exceed LV = ON,
Undershoot LV hyst. =
No teleg.

Exceed LV = OFF,
Undershoot LV hyst. =
No teleg.

Undershoot LV = ON,
Exceed LV + hyst. =
No teleg.

Undershoot LV = OFF,
Exceed LV + hyst. =
No teleg.

Exceed LV = No teleg.,
Undershoot LV hyst. = OFF

Exceed LV = No teleg.,
Undershoot LV hyst. = ON

Undershoot LV =
No teleg.,
Exceed LV + hyst. = OFF

Undershoot LV =
No teleg.,
Exceed LV + hyst. = ON

External limiting value 1

No

16 bit value

8 bit value

Save limiting value via
switching obj. (teaching)

i In conjunction with the parameters "Limiting value 1" and "Activation of limiting value 1", define the thresholds at which the limiting value object is set to "1" or "0" when they are exceeded or fallen below.

Here, it is possible to set which action is to be executed when the limiting value is crossed from an exactly defined direction.

i In conjunction with the parameters "Limiting value 1" and "Hysteresis limiting value 1", define the thresholds at which the limiting value object is set to "1" or "0" when they are exceeded or undershot.

No external limiting value 1 is parametrized

The limiting value is specified by an external device using a 2-byte value object.

The limiting value is specified by an external device using a 1-byte value object.

When this external switching object is used, the current measured value of the

Cycl. Sending of limiting value 1 (x 10 s) **0...120**

i If this parameter "Sending of limiting value for value change" is set to "No" and the parameter "Cyclic sending of the limiting value" is set to "0", then the limiting value is not sent at all.

Set whether and at what time interval the limiting value is sent here. The set value multiplied by 10 is the repeat time in seconds. It is thus possible to set the cycle time in step widths of 10 seconds. The value "0" indicates that the limiting value object is not transmitted cyclically.

i If this parameter "Sending of limiting value for value change" is set to "No" and the parameter "Cyclic sending of the limiting value" is set to "0", then the limiting value is not sent at all.

Wind speed limiting value 2 (Only visible if the parameter 'Wind speed' under 'General' is set to 'Activated' and the parameter 'Limiting values' is set here to 'Limiting values 1 and 2 activated'!)

Limiting value 2 in m/s

- 1 m/s (wind speed 1)
- 3 m/s (wind speed 2)
- 5 m/s (wind speed 3)**
- 8 m/s (wind speed 4)
- 10 m/s (wind speed 5)
- 12 m/s (wind speed 6)
- 15 m/s (wind speed 7)
- 20 m/s (wind speed 8)
- 22 m/s (wind speed 9)
- 25 m/s (wind speed 10)
- 30 m/s (wind speed 11)
- 35 m/s (wind speed 12)

Set the threshold for the limiting value in the range from 1 m/s to 35 m/s here.

i In conjunction with the parameters "Limiting value 2" and "Hysteresis limiting value 2", define the thresholds at which the limiting value object is set to "1" or "0" when they are exceeded or undershot.

Hysteresis limiting value 2 in m/s

- 1 m/s
- 3 m/s**
- 5 m/s
- 8 m/s
- 10 m/s

Set here the hysteresis in the range from no hysteresis to 10 m/s.

i In conjunction with the parameters "Limiting value 2" and "Activation of limiting value 2", define the thresholds at which the limiting value object is set to "1" or "0" when they are exceeded or fallen below.

Activation of limiting value 2
LV=Limiting value,
Hyst.=Hysteresis

**Exceed LV = ON,
Undershoot LV - hyst. = OFF**

Here, it is possible to set which action is to be executed when the limiting value is crossed from an exactly defined direction.

Exceed LV = OFF,
Undershoot LV - hyst. = ON

i In conjunction with the parameters "Limiting value 2" and "Hysteresis limiting value 2", define the thresholds at which the limiting value object is set to "1" or "0" when they are exceeded or undershot.

Undershoot LV = ON,
Exceed LV + hyst. = OFF

Undershoot LV = OFF,
Exceed LV + hyst. = ON

Exceed LV = ON,
Undershoot LV hyst. =

	No telegr.	
	Exceed LV = OFF, Undershoot LV hyst. = No telegr.	
	Undershoot LV = ON, Exceed LV + hyst. = No telegr.	
	Undershoot LV = OFF, Exceed LV + hyst. = No telegr.	
	Exceed LV = No telegr., Undershoot LV hyst. = OFF	
	Exceed LV = No telegr., Undershoot LV hyst. = ON	
	Undershoot LV = No telegr., Exceed LV + hyst. = OFF	
	Undershoot LV = No telegr., Exceed LV + hyst. = ON	
External limiting value 2	No	No external limiting value 2 is parametrized
	16 bit value	The limiting value is specified by an external device using a 2-byte value object.
	8 bit value	The limiting value is specified by an external device using a 1-byte value object.
	Save limiting value via switching obj. (teaching)	When this external switching object is used, the current measured value of the sensor can be defined as limiting value, e.g. by a button-press.
		<ul style="list-style-type: none"> i Using an external object, the user of the building can set the limiting value to suit their needs, without having to change the configuration. i During a download, the external values are overwritten with the ETS data. Only when a value is again received after a download is this value processed again.
Switch-on delay limiting value 2	No delay 1s delay 3s delay 5s delay 10s delay 15s delay 30s delay 1min delay 3min delay 5min delay 10min delay	Only after the time set here will the current state of the limiting value be accepted in the limiting value object. This means that <ul style="list-style-type: none"> - a change in the limiting value to "1" will only be sent after this time elapses, - in the case of cyclic sending of the limiting value, the changed value "1" is only sent after this time expires. Therefore a "0" continues to be sent

4.2.4.9 Parameter group "Wind direction"

Description	Values	Comment
<input type="checkbox"/> Wind direction (Only visible if the parameter 'Wind direction' under 'General' is set to 'Activated!') (Measuring range 0...360°)		
Send measured value on (10 s send delay)	0.5% measured value difference 1% measured value difference 3% measured value difference 10% measured value difference	So as not to burden the bus with very frequent telegrams, the measured value should not be sent for every tiny change. While taking the measurement task into account, a maximum possible value should be set here. <input type="checkbox"/> The percentage specification for the measured value difference is always relative to the measuring range upper range value! <input type="checkbox"/> A fixed sending delay of 10 seconds is set.
Cycl. sending of the measured value (x 10 s)	0 ...120	Set here whether and at what time interval the value is sent. The set value multiplied by 10 is the repeat time in seconds. It is thus possible to set the cycle time in step widths of 10 seconds. The value "0" means that no cyclic sending is carried out. <input type="checkbox"/> The cyclic telegrams sent via this setting are independent of the telegrams resulting from the setting "Send measured value on... measured value difference".
Text direction north	no predefined text	In the text field of this parameter, a text of up to 14 characters can be entered. The text entered here can be output via the 14-byte "Measured value, wind orientation" communication object for north wind.
Text direction north east	no predefined text	In the text field of this parameter, a text of up to 14 characters can be entered. The text entered here can be output via the 14-byte "Measured value, wind orientation" communication object for wind from the direction north-east.
Text direction east	no predefined text	In the text field of this parameter, a text of up to 14 characters can be entered. The text entered here can be output via the 14-byte "Measured value, wind orientation" communication object for east wind.

Text direction south east	no predefined text	In the text field of this parameter, a text of up to 14 characters can be entered. The text entered here can be output via the 14-byte "Measured value, wind orientation" communication object for wind from the direction south-east.
Text direction south	no predefined text	In the text field of this parameter, a text of up to 14 characters can be entered. The text entered here can be output via the 14-byte "Measured value, wind orientation" communication object for south wind.
Text direction south west	no predefined text	In the text field of this parameter, a text of up to 14 characters can be entered. The text entered here can be output via the 14-byte "Measured value, wind orientation" communication object for wind from the direction south-west.
Text direction west	no predefined text	In the text field of this parameter, a text of up to 14 characters can be entered. The text entered here can be output via the 14-byte "Measured value, wind orientation" communication object for west wind.
Text direction north west	no predefined text	In the text field of this parameter, a text of up to 14 characters can be entered. The text entered here can be output via the 14-byte "Measured value, wind orientation" communication object for wind from the direction north-west.

Wind area signal (Only visible if the parameter 'Wind direction' under 'General' is set to 'Activated!')

Limiting value 1 in °	<ul style="list-style-type: none"> 0 ° 22.5 ° 45 ° 67.5 ° 90 ° 112.5 ° 135 ° 157.5 ° 180 ° 202.5 ° 225 ° 247.5 ° 270 ° 292.5 ° 315 ° 337.5 ° 	<p>Set the lower threshold for the limiting value in the range from 0° to 337.5° here.</p> <p>i The "Limiting value 1 in °" parameter defines the lower limiting value of the wind area signal. If the limiting value is exceeded or the limiting value is undershot minus hysteresis, the "Measured value, wind area signal" communication object sends a "1" telegram, a "0" telegram or no telegram to the KNX depending on the setting of the "Activation area" parameter.</p>
-----------------------	--	---

Limiting value 2 in °	0° 22.5° 45° 67.5° 90° 112.5° 135° 157.5° 180° 202.5° 225° 247.5° 270° 292.5° 315° 337.5°	<p>Set the threshold for the upper limiting value in the range from 0° to 337.5° here.</p> <p>i The "Limiting value 2 in °" parameter defines the upper limiting value of the wind area signal. If the limiting value is undershot or the limiting value is exceeded plus hysteresis, the "Measured value, wind area signal" communication object sends a "1" telegram, a "0" telegram or no telegram to the KNX depending on the setting of the "Activation area" parameter.</p>
Hysteresis in °	10° 15° 20° 45°	<p>Set the hysteresis in the limiting value in range from 10° to 45° here. Limiting value 1 and limiting value 2 work with the hysteresis value set here. The hysteresis is taken into account if the present wind direction leaves the defined wind area. This wind area in ° indicates the direction that the wind must flow from so that the device outputs a wind area signal to the KNX. If the wind direction between the defined limits (limiting value 1, limiting value 2) is present, then a logical "1" is sent to the KNX. If the wind is in a different compass direction area outside the defined limits (limiting value 1 minus hysteresis, limiting value 2 plus hysteresis), then a "0" is sent to the KNX.</p>
Activation area (LV=Limiting value, Hyst.=Hysteresis)	<p>Measured value in range=ON, Undershoot=OFF, Exceed=OFF</p> <p>Measured value in range=OFF, Undershoot=ON, Exceed=ON</p> <p>Measured value in range=No telegram, Undershoot=OFF, Exceed=OFF</p> <p>Measured value in range=No telegram, Undershoot=ON, Exceed=ON</p>	<p>The parameter defines when the wind area signal is activated.</p> <p>The activation of the wind area signal depends on the following criteria:</p> <ul style="list-style-type: none"> - Is the measured wind direction within the defined area? - Is the lower limiting value minus hysteresis undershot? - Is the upper limiting value plus hysteresis exceeded? <p>i Range = Range is limited by limiting value 1 and limiting value 2</p> <p>i Undershoot = Lower limiting value undershot minus hysteresis</p>

	<p>Measured value in range=OFF, Undershoot=no telegram, Exceed=no telegram</p> <p>Measured value in range=ON, Undershoot=no telegram, Exceed=no telegram</p>	<p>i Exceed = Upper limiting value exceeded plus hysteresis</p>
External limiting value 1	No	<p>No external limiting value 1 is parametrized. The lower limiting value cannot be specified via communication object.</p>
	<p>16 bit value, DPT 9.xxx</p>	<p>The "Wind direction" communication object is enabled. The "Limiting value 1 in °" defined in the parameters can be changed via the "Wind direction external limiting value 1" communication object without reprogramming in ETS and during operation. In this case, the limiting value is preset via a 2-byte communication object.</p> <p>i The external limiting value overwrites the configured value in the ETS. The configured "Limiting value 1 in °" in the ETS is reactivated when the application program is reprogrammed.</p> <p>i Received limiting values beyond the value range (0...360) are ignored.</p>
	<p>8 bit value, DPT 5.001</p>	<p>The "Wind direction" communication object is enabled. The "Limiting value 1 in °" defined in the parameters can be changed via the "Wind direction external limiting value 1" communication object without reprogramming in ETS and during operation. In this case, the limiting value is preset via a 1-byte communication object. The wind direction can be specified in percent (0% = 0°, 1% = 3.6°, 2% = 7.2, ..., 10% = 36°, ..., 50% = 180°, ..., 100% = 360°).</p> <p>i The external limiting value overwrites the configured value in the ETS. The configured "Limiting value 1 in °" in the ETS is reactivated when the application program is reprogrammed.</p>
	<p>8 bit value, DPT 5.003</p>	<p>The "Wind direction" communication object is enabled. The "Limiting value 1</p>

	<p>in °" defined in the parameters can be changed via the "Wind direction external limiting value 1" communication object without reprogramming in ETS and during operation. In this case, the limiting value is preset via a 1-byte communication object. The wind direction can be specified in degrees (0° = 0°, 1° = 1°, 2° = 2°, ..., 360° = 360°).</p> <p>i The external limiting value overwrites the configured value in the ETS. The configured "Limiting value 1 in °" in the ETS is reactivated when the application program is reprogrammed.</p>
<p>External limiting value 2 No</p>	<p>No external limiting value 2 is parametrized. The lower limiting value cannot be specified via communication object.</p>
<p>16 bit value, DPT 9.xxx</p>	<p>The "Wind direction" communication object is enabled. The "Limiting value 2 in °" defined in the parameters can be changed via the "Wind direction external limiting value 2" communication object without reprogramming in ETS and during operation. In this case, the limiting value is preset via a 2-byte communication object.</p> <p>i The external limiting value overwrites the configured value in the ETS. The configured "Limiting value 2 in °" in the ETS is reactivated when the application program is reprogrammed.</p> <p>i Received limiting values beyond the value range (0...360) are ignored.</p>
<p>8 bit value, DPT 5.001</p>	<p>The "Wind direction" communication object is enabled. The "Limiting value 2 in °" defined in the parameters can be changed via the "Wind direction external limiting value 2" communication object without reprogramming in ETS and during operation. In this case, the limiting value is preset via a 1-byte communication object. The wind direction can be specified in percent (0% = 0°, 1% = 3.6°, 2% = 7.2°, ..., 10% = 36°, ..., 50% = 180°, ..., 100% = 360°).</p>

8 bit value, DPT 5.003

i The external limiting value overwrites the configured value in the ETS. The configured "Limiting value 2 in °" in the ETS is reactivated when the application program is reprogrammed.

The "Wind direction" communication object is enabled. The "Limiting value 2 in °" defined in the parameters can be changed via the "Wind direction external limiting value 2" communication object without reprogramming in ETS and during operation. In this case, the limiting value is preset via a 1-byte communication object. The wind direction can be specified in degrees ($0^\circ = 0^\circ$, $1^\circ = 1^\circ$, $2^\circ = 2^\circ$, ..., $360^\circ = 360^\circ$).

i The external limiting value overwrites the configured value in the ETS. The configured "Limiting value 2 in °" in the ETS is reactivated when the application program is reprogrammed.

Switch-on delay area message

No delay
 1s delay
 3s delay
 5s delay
 10s delay
 15s delay
 30s delay
 1min delay
3min delay
 5min delay
 10min delay
 15min delay
 30min delay
 60min delay

The delay time configured here is evaluated when the value of the wind area signal changes from "0" to "1". The wind area signal is sent to the KNX after the switch-on delay has elapsed. If "No delay" is set, the "Measured value, wind area signal" communication object sends the current value immediately after a change.

i If one of the options of the "Activation area" parameters is set to "No telegram", the device never sends out such a value telegram.

Switch-off delay area message

No delay
 1s delay
 3s delay
 5s delay
 10s delay
 15s delay
 30s delay
 1min delay
 3min delay
 5min delay
10min delay
 15min delay
 30min delay
 60min delay

The delay time configured here is evaluated when the value of the wind area signal changes from "1" to "0". The wind area signal is sent to the KNX after the switch-off delay has elapsed. If "No delay" is set, the "Measured value, wind area signal" communication object sends the current value immediately after a change.

i If one of the options of the "Activation area" parameters is set to "No telegram", the device never sends out such a value telegram.

No

Sending the area message on value change

Yes

The wind area signal is not sent following a change.
If the parameter "Cyclic sending of the area message" is set to at least 1, then the limiting value object is sent cyclically regardless of any change.

The wind area signal is sent following a change from "0" to "1" or from "1" to "0".

i If this parameter "Sending the area message on value change" is set to "No" and the parameter "Cyclic sending of the limiting value" is set to "0", then the limiting value is not sent at all.

Cycl. Sending of the area message (x 10 s)

0...120

Set here whether and at what time an interval the wind area signal is sent. The set value multiplied by 10 is the repeat time in seconds. It is thus possible to set the cycle time in step widths of 10 seconds.

The value "0" means that no cyclic sending is carried out.

i The cyclic telegrams sent via this setting are independent of the telegrams resulting from the setting "Sending the area message on value change".

4.2.4.10 Parameter group "Precipitation"

Description	Values	Comment
<input type="checkbox"/> Precipitation (Only visible if the parameter 'Precipitation' under 'General' is set to 'Activated'!)		
Limiting values	not activated Limiting value 1 activated Limiting values 1 and 2 activated	Select here whether this sensor should have limiting values, and how many. <input type="checkbox"/> Limiting values that are not activated will not be displayed!
<input type="checkbox"/> Precipitation limiting value 1 (Only visible if the parameter 'Precipitation' under 'General' is set to 'Activated' and the parameter 'Limiting values' is set here to 'Limiting value 1 activated' or to 'Limiting values 1 and 2 activated'!)		
Limiting value 1	ON when raining OFF when raining	Here, you can set whether, when there is precipitation, a '1' (for rain ON) or a '0' (for rain OFF) is sent <input type="checkbox"/> If the proper 24V supply voltage is not present, then rain will always be reported.
Switch-on delay limiting value 1	No delay 1s delay 3s delay 5s delay 10s delay 15s delay 30s delay 1min delay 3min delay 5min delay 10min delay 15min delay 30min delay 60min delay	Only after the time set here will the current state of the limiting value be accepted in the limiting value object. This means that - a change in the limiting value to "1" will only be sent after this time elapses, - in the case of cyclic sending of the limiting value, the changed value "1" is only sent after this time expires. Therefore a "0" continues to be sent while the timer for the delay time is running. <input type="checkbox"/> If the parameter "Activation limiting value" for a condition is set to "No telegram", then the cyclic telegrams are also suppressed when the set condition is fulfilled.
Switch-off delay limiting value 1	No delay 1s delay 3s delay 5s delay 10s delay 15s delay 30s delay 1min delay 3min delay 5min delay 10min delay 15min delay 30min delay 60min delay	Only after the time set here will the current state of the limiting value be accepted in the limiting value object. This means that - a change in the limiting value to "0" will only be sent after this time elapses, - in the case of cyclic sending of the limiting value, the changed value "0" is only sent after this time expires. Therefore a "1" continues to be sent while the timer for the delay time is running. <input type="checkbox"/> If the parameter "Activation limiting value" for a condition is set to "No telegram", then the cyclic telegrams are also suppressed when the set condition is fulfilled.
Sending of limiting value 1 for value change	No	The limiting value object is not sent following a change. If the parameter "Cyclic sending of the

	Yes	<p>limiting value" is set to at least 1, then the limiting value object is sent cyclically regardless of any change.</p> <p>The limiting value object is sent following a change from "0" to "1" or from "1" to "0".</p> <p>i If this parameter "Sending of limiting value for value change" is set to "No" and the parameter "Cyclic sending of the limiting value" is set to "0", then the limiting value is not sent at all.</p>
Cycl. Sending of limiting value 1 (x 10 s)	0...120	<p>Set whether and at what time interval the limiting value is sent here. The set value multiplied by 10 is the repeat time in seconds. It is thus possible to set the cycle time in step widths of 10 seconds. The value "0" indicates that the limiting value object is not transmitted cyclically.</p> <p>i If this parameter "Sending of limiting value for value change" is set to "No" and the parameter "Cyclic sending of the limiting value" is set to "0", then the limiting value is not sent at all.</p>
<p>☐- Precipitation limiting value 2 (Only visible if the parameter 'Precipitation' under 'General' is set to 'Activated' and the parameter 'Limiting values' is set here to 'Limiting value 1 activated' or to 'Limiting values 1 and 2 activated'!)</p>		
Limiting value 1	ON when raining OFF when raining	<p>Here, you can set whether, when there is precipitation, a '1' (for rain ON) or a '0' (for rain OFF) is sent</p> <p>i If the proper 24V supply voltage is not present, then rain will always be reported.</p>
Switch-on delay limiting value 2	No delay 1s delay 3s delay 5s delay 10s delay 15s delay 30s delay 1min delay 3min delay 5min delay 10min delay 15min delay 30min delay 60min delay	<p>Only after the time set here will the current state of the limiting value be accepted in the limiting value object. This means that</p> <ul style="list-style-type: none"> - a change in the limiting value to "1" will only be sent after this time elapses, - in the case of cyclic sending of the limiting value, the changed value "1" is only sent after this time expires. <p>Therefore a "0" continues to be sent while the timer for the delay time is running.</p> <p>i If the parameter "Activation limiting value" for a condition is set to "No telegram", then the cyclic telegrams are also suppressed when the set condition is fulfilled.</p>
Switch-off delay limiting value 2	No delay 1s delay 3s delay 5s delay 10s delay	<p>Only after the time set here will the current state of the limiting value be accepted in the limiting value object. This means that</p> <ul style="list-style-type: none"> - a change in the limiting value to "0" will

	<p>15s delay 30s delay 1min delay 3min delay 5min delay 10min delay 15min delay 30min delay 60min delay</p>	<p>only be sent after this time elapses, - in the case of cyclic sending of the limiting value, the changed value "0" is only sent after this time expires. Therefore a "1" continues to be sent while the timer for the delay time is running.</p> <p>i If the parameter "Activation limiting value" for a condition is set to "No telegram", then the cyclic telegrams are also suppressed when the set condition is fulfilled.</p>
<p>Sending of limiting value 2 for value change</p>	<p>No</p> <p>Yes</p>	<p>The limiting value object is not sent following a change. If the parameter "Cyclic sending of the limiting value" is set to at least 1, then the limiting value object is sent cyclically regardless of any change.</p> <p>The limiting value object is sent following a change from "0" to "1" or from "1" to "0".</p> <p>i If this parameter "Sending of limiting value for value change" is set to "No" and the parameter "Cyclic sending of the limiting value" is set to "0", then the limiting value is not sent at all.</p>
<p>Cycl. Sending of limiting value 2 (x 10 s)</p>	<p>0...120</p>	<p>Set whether and at what time interval the limiting value is sent here. The set value multiplied by 10 is the repeat time in seconds. It is thus possible to set the cycle time in step widths of 10 seconds. The value "0" indicates that the limiting value object is not transmitted cyclically.</p> <p>i If this parameter "Sending of limiting value for value change" is set to "No" and the parameter "Cyclic sending of the limiting value" is set to "0", then the limiting value is not sent at all.</p>

4.2.4.11 Parameter group "Absolute humidity"

Description	Values	Comment
<input type="checkbox"/> Absolute humidity (Only visible if the parameter 'Absolute humidity' under 'General' is set to 'Activated!') (Measuring range 0...100 g/m ³)		
Limiting values	not activated Limiting value 1 activated Limiting values 1 and 2 activated	Select here whether this sensor should have limiting values, and how many. <input type="checkbox"/> Limiting values that are not activated will not be displayed!
Send measured value on (10 s send delay)	0.5% measured value difference 1% measured value difference 3% measured value difference 10% measured value difference	So as not to burden the bus with very frequent telegrams, the measured value should not be sent for every tiny change. While taking the measurement task into account, a maximum possible value should be set here. <input type="checkbox"/> The percentage specification for the measured value difference is always relative to the measuring range upper range value! <input type="checkbox"/> A fixed sending delay of 10 seconds is set.
Cycl. sending of the measured value (x 10 s)	0...120	Set here whether and at what time interval the value is sent. The set value multiplied by 10 is the repeat time in seconds. It is thus possible to set the cycle time in step widths of 10 seconds. The value "0" means that no cyclic sending is carried out. <input type="checkbox"/> The cyclic telegrams sent via this setting are independent of the telegrams resulting from the setting "Send measured value on... measured value difference".
DPT of measured value	16 bit value, DPT 9.029 16 bit value, DPT 7.001	This parameter defines which data point type the "Measured value absolute humidity" communication object corresponds to. The device sends the calculated absolute humidity value to the KNX in the set format.
<input type="checkbox"/> Absolute humidity limiting value 1 (Only visible if the parameter 'Absolute humidity' under 'General' is set to 'Activated' and the parameter 'Limiting values' is set here to 'Limiting value 1 activated' or to 'Limiting values 1 and 2 activated!')		
Limiting value 1 in g/m ³	10 g/m ³ 15 g/m ³ 20 g/m ³ 25 g/m ³ 30 g/m³ 35 g/m ³ 40 g/m ³ 50 g/m ³ 60 g/m ³	Set the threshold for the limiting value in the range from 10 to 80 g/m ³ here. <input type="checkbox"/> In conjunction with the parameters "Limiting value 1" and "Hysteresis limiting value 1", define the thresholds at which the limiting value object is set to "1" or "0" when they are exceeded or undershot.

	70 g/m ³ 80 g/m ³	
Hysteresis limiting value 1 in g/m ³	No hysteresis 2 g/m ³ 3 g/m³ 5 g/m ³ 7 g/m ³ 10 g/m ³	Set here the hysteresis in the range from no hysteresis to 10 g/m ³ . i In conjunction with the parameters "Limiting value 1" and "Activation of limiting value 1", define the thresholds at which the limiting value object is set to "1" or "0" when they are exceeded or fallen below.
Activation of limiting value 1 LV=Limiting value, Hyst.=Hysteresis	Exceed LV = ON, Undershoot LV - hyst. = OFF Exceed LV = OFF, Undershoot LV - hyst. = ON Undershoot LV = ON, Exceed LV + hyst. = OFF Undershoot LV = OFF, Exceed LV + hyst. = ON Exceed LV = ON, Undershoot LV hyst. = No telegr. Exceed LV = OFF, Undershoot LV hyst. = No telegr. Undershoot LV = ON, Exceed LV + hyst. = No telegr. Undershoot LV = OFF, Exceed LV + hyst. = No telegr. Exceed LV = No telegr., Undershoot LV hyst. = OFF Exceed LV = No telegr., Undershoot LV hyst. = ON Undershoot LV = No telegr., Exceed LV + hyst. = OFF Undershoot LV = No telegr., Exceed LV + hyst. = ON	Here, it is possible to set which action is to be executed when the limiting value is crossed from an exactly defined direction. i In conjunction with the parameters "Limiting value 1" and "Hysteresis limiting value 1", define the thresholds at which the limiting value object is set to "1" or "0" when they are exceeded or undershot.
External limiting value 1	No 16 bit value	No external limiting value 1 is parametrized The limiting value is specified by an external device using a 2-byte value object.

	8 bit value	The limiting value is specified by an external device using a 1-byte value object.
Switch-on delay limiting value 1	No delay 1s delay 3s delay 5s delay 10s delay 15s delay 30s delay 1min delay 3min delay 5min delay 10min delay 15min delay 30min delay 60min delay	<p>Only after the time set here will the current state of the limiting value be accepted in the limiting value object. This means that</p> <ul style="list-style-type: none"> - a change in the limiting value to "1" will only be sent after this time elapses, - in the case of cyclic sending of the limiting value, the changed value "1" is only sent after this time expires. <p>Therefore a "0" continues to be sent while the timer for the delay time is running.</p> <p>i If the parameter "Activation limiting value" for a condition is set to "No telegram", then the cyclic telegrams are also suppressed when the set condition is fulfilled.</p>
Switch-off delay limiting value 1	No delay 1s delay 3s delay 5s delay 10s delay 15s delay 30s delay 1min delay 3min delay 5min delay 10min delay 15min delay 30min delay 60min delay	<p>Only after the time set here will the current state of the limiting value be accepted in the limiting value object. This means that</p> <ul style="list-style-type: none"> - a change in the limiting value to "0" will only be sent after this time elapses, - in the case of cyclic sending of the limiting value, the changed value "0" is only sent after this time expires. <p>Therefore a "1" continues to be sent while the timer for the delay time is running.</p> <p>i If the parameter "Activation limiting value" for a condition is set to "No telegram", then the cyclic telegrams are also suppressed when the set condition is fulfilled.</p>
Sending of limiting value 1 for value change	No	<p>The limiting value object is not sent following a change.</p> <p>If the parameter "Cyclic sending of the limiting value" is set to at least 1, then the limiting value object is sent cyclically regardless of any change.</p>
	Yes	<p>The limiting value object is sent following a change from "0" to "1" or from "1" to "0".</p> <p>i If this parameter "Sending of limiting value for value change" is set to "No" and the parameter "Cyclic sending of the limiting value" is set to "0", then the limiting value is not sent at all.</p>
Cycl. Sending of limiting value 1 (x 10 s)	0...120	<p>Set whether and at what time interval the limiting value is sent here. The set value multiplied by 10 is the repeat time in seconds. It is thus possible to set the cycle time in step widths of 10 seconds.</p>

The value "0" indicates that the limiting value object is not transmitted cyclically.

i If this parameter "Sending of limiting value for value change" is set to "No" and the parameter "Cyclic sending of the limiting value" is set to "0", then the limiting value is not sent at all.

☐ Absolute humidity limiting value 2 (Only visible if the parameter 'Absolute humidity' under 'General' is set to 'Activated' and the parameter 'Limiting values' is set here to 'Limiting values 1 and 2 activated'!)

Limiting value 2 in g/m³ 10 g/m³
 15 g/m³
 20 g/m³
 25 g/m³
 30 g/m³
 35 g/m³
 40 g/m³
 50 g/m³
 60 g/m³
 70 g/m³
 80 g/m³

Set the threshold for the limiting value in the range from 10 to 80 g/m³ here.

i In conjunction with the parameters "Limiting value 2" and "Hysteresis limiting value 2", define the thresholds at which the limiting value object is set to "1" or "0" when they are exceeded or undershot.

Hysteresis limiting value 2 in g/m³ No hysteresis
 2 g/m³
 3 g/m³
 5 g/m³
 7 g/m³
 10 g/m³

Set here the hysteresis in the range from no hysteresis to 10 g/m³.

i In conjunction with the parameters "Limiting value 2" and "Activation of limiting value 2", define the thresholds at which the limiting value object is set to "1" or "0" when they are exceeded or fallen below.

Activation of limiting value 2
 LV=Limiting value,
 Hyst.=Hysteresis

**Exceed LV = ON,
 Undershoot LV - hyst. = OFF**

Here, it is possible to set which action is to be executed when the limiting value is crossed from an exactly defined direction.

Exceed LV = OFF,
 Undershoot LV - hyst. = ON

i In conjunction with the parameters "Limiting value 2" and "Hysteresis limiting value 2", define the thresholds at which the limiting value object is set to "1" or "0" when they are exceeded or undershot.

Undershoot LV = ON,
 Exceed LV + hyst. = OFF

Undershoot LV = OFF,
 Exceed LV + hyst. = ON

Exceed LV = ON,
 Undershoot LV hyst. =
 No telegr.

Exceed LV = OFF,
 Undershoot LV hyst. =
 No telegr.

Undershoot LV = ON,
 Exceed LV + hyst. =
 No telegr.

Undershoot LV = OFF,

	Exceed LV + hyst. = No telegr.	
	Exceed LV = No telegr., Undershoot LV hyst. = OFF	
	Exceed LV = No telegr., Undershoot LV hyst. = ON	
	Undershoot LV = No telegr., Exceed LV + hyst. = OFF	
	Undershoot LV = No telegr., Exceed LV + hyst. = ON	
External limiting value 2	No	No external limiting value 2 is parametrized
	16 bit value	The limiting value is specified by an external device using a 2-byte value object.
	8 bit value	The limiting value is specified by an external device using a 1-byte value object.
Switch-on delay limiting value 2	No delay 1s delay 3s delay 5s delay 10s delay 15s delay 30s delay 1min delay 3min delay 5min delay 10min delay 15min delay 30min delay 60min delay	Only after the time set here will the current state of the limiting value be accepted in the limiting value object. This means that - a change in the limiting value to "1" will only be sent after this time elapses, - in the case of cyclic sending of the limiting value, the changed value "1" is only sent after this time expires. Therefore a "0" continues to be sent while the timer for the delay time is running. i If the parameter "Activation limiting value" for a condition is set to "No telegram", then the cyclic telegrams are also suppressed when the set condition is fulfilled.
Switch-off delay limiting value 2	No delay 1s delay 3s delay 5s delay 10s delay 15s delay 30s delay 1min delay 3min delay 5min delay 10min delay 15min delay 30min delay 60min delay	Only after the time set here will the current state of the limiting value be accepted in the limiting value object. This means that - a change in the limiting value to "0" will only be sent after this time elapses, - in the case of cyclic sending of the limiting value, the changed value "0" is only sent after this time expires. Therefore a "1" continues to be sent while the timer for the delay time is running. i If the parameter "Activation limiting value" for a condition is set to "No telegram", then the cyclic telegrams are also suppressed when the set condition is fulfilled.

Sending of limiting value 2 for value change	No	<p>The limiting value object is not sent following a change.</p> <p>If the parameter "Cyclic sending of the limiting value" is set to at least 1, then the limiting value object is sent cyclically regardless of any change.</p>
	Yes	<p>The limiting value object is sent following a change from "0" to "1" or from "1" to "0".</p> <p>i If this parameter "Sending of limiting value for value change" is set to "No" and the parameter "Cyclic sending of the limiting value" is set to "0", then the limiting value is not sent at all.</p>
Cycl. Sending of limiting value 2 (x 10 s)	0...120	<p>Set whether and at what time interval the limiting value is sent here. The set value multiplied by 10 is the repeat time in seconds. It is thus possible to set the cycle time in step widths of 10 seconds. The value "0" indicates that the limiting value object is not transmitted cyclically.</p> <p>i If this parameter "Sending of limiting value for value change" is set to "No" and the parameter "Cyclic sending of the limiting value" is set to "0", then the limiting value is not sent at all.</p>

4.2.4.12 Parameter group "Relative humidity"

Description	Values	Comment
<input type="checkbox"/> Relative humidity (Only visible if the parameter 'Relative humidity' under 'General' is set to 'Activated!') (Measuring range 0...100 %)		
Limiting values	not activated Limiting value 1 activated Limiting values 1 and 2 activated	Select here whether this sensor should have limiting values, and how many. ⓘ Limiting values that are not activated will not be displayed!
Send measured value on (10 s send delay)	0.5% measured value difference 1% measured value difference 3% measured value difference 10% measured value difference	So as not to burden the bus with very frequent telegrams, the measured value should not be sent for every tiny change. While taking the measurement task into account, a maximum possible value should be set here. ⓘ The percentage specification for the measured value difference is always relative to the measuring range upper range value! ⓘ A fixed sending delay of 10 seconds is set.
Cycl. sending of the measured value (x 10 s)	0...120	Set here whether and at what time interval the value is sent. The set value multiplied by 10 is the repeat time in seconds. It is thus possible to set the cycle time in step widths of 10 seconds. The value "0" means that no cyclic sending is carried out. ⓘ The cyclic telegrams sent via this setting are independent of the telegrams resulting from the setting "Send measured value on... measured value difference".
<input type="checkbox"/> Relative humidity limiting value 1 (Only visible if the parameter 'Relative humidity' under 'General' is set to 'Activated' and the parameter 'Limiting values' is set here to 'Limiting value 1 activated' or to 'Limiting values 1 and 2 activated!')		
Limiting value 1 in %	20 % 30 % 40 % 45 % 50 % 55 % 60 % 65 % 70 % 75 % 80 % 90 %	Set the threshold for the limiting value in the range from 20 to 90 % here. ⓘ In conjunction with the parameters "Limiting value 1" and "Hysteresis limiting value 1", define the thresholds at which the limiting value object is set to "1" or "0" when they are exceeded or undershot.
Hysteresis limiting value 1 in %	No hysteresis 10 % 15 % 20 %	Set here the hysteresis in the range from no hysteresis to 20 %.

Activation of limiting value 1 LV=Limiting value, Hyst.=Hysteresis	Exceed LV = ON, Undershoot LV - hyst. = OFF	ⓘ In conjunction with the parameters "Limiting value 1" and "Activation of limiting value 1", define the thresholds at which the limiting value object is set to "1" or "0" when they are exceeded or fallen below.
	Exceed LV = OFF, Undershoot LV - hyst. = ON	Here, it is possible to set which action is to be executed when the limiting value is crossed from an exactly defined direction.
	Undershoot LV = ON, Exceed LV + hyst. = OFF	ⓘ In conjunction with the parameters "Limiting value 1" and "Hysteresis limiting value 1", define the thresholds at which the limiting value object is set to "1" or "0" when they are exceeded or undershot.
	Undershoot LV = OFF, Exceed LV + hyst. = ON	
	Exceed LV = ON, Undershoot LV hyst. = No teleg.	
	Exceed LV = OFF, Undershoot LV hyst. = No teleg.	
	Undershoot LV = ON, Exceed LV + hyst. = No teleg.	
	Undershoot LV = OFF, Exceed LV + hyst. = No teleg.	
	Exceed LV = No teleg., Undershoot LV hyst. = OFF	
	Exceed LV = No teleg., Undershoot LV hyst. = ON	
	Undershoot LV = No teleg., Exceed LV + hyst. = OFF	
	Undershoot LV = No teleg., Exceed LV + hyst. = ON	
External limiting value 1	No	No external limiting value 1 is parametrized
	16 bit value	The limiting value is specified by an external device using a 2-byte value object.
	8 bit value	The limiting value is specified by an external device using a 1-byte value object.
Switch-on delay limiting value 1	No delay 1s delay 3s delay	Only after the time set here will the current state of the limiting value be accepted in the limiting value object.

	5s delay 10s delay 15s delay 30s delay 1min delay 3min delay 5min delay 10min delay 15min delay 30min delay 60min delay	<p>This means that</p> <ul style="list-style-type: none"> - a change in the limiting value to "1" will only be sent after this time elapses, - in the case of cyclic sending of the limiting value, the changed value "1" is only sent after this time expires. <p>Therefore a "0" continues to be sent while the timer for the delay time is running.</p> <p>i If the parameter "Activation limiting value" for a condition is set to "No telegram", then the cyclic telegrams are also suppressed when the set condition is fulfilled.</p>
Switch-off delay limiting value 1	No delay 1s delay 3s delay 5s delay 10s delay 15s delay 30s delay 1min delay 3min delay 5min delay 10min delay 15min delay 30min delay 60min delay	<p>Only after the time set here will the current state of the limiting value be accepted in the limiting value object.</p> <p>This means that</p> <ul style="list-style-type: none"> - a change in the limiting value to "0" will only be sent after this time elapses, - in the case of cyclic sending of the limiting value, the changed value "0" is only sent after this time expires. <p>Therefore a "1" continues to be sent while the timer for the delay time is running.</p> <p>i If the parameter "Activation limiting value" for a condition is set to "No telegram", then the cyclic telegrams are also suppressed when the set condition is fulfilled.</p>
Sending of limiting value 1 for value change	<p>No</p> <p>Yes</p>	<p>The limiting value object is not sent following a change.</p> <p>If the parameter "Cyclic sending of the limiting value" is set to at least 1, then the limiting value object is sent cyclically regardless of any change.</p> <p>The limiting value object is sent following a change from "0" to "1" or from "1" to "0".</p> <p>i If this parameter "Sending of limiting value for value change" is set to "No" and the parameter "Cyclic sending of the limiting value" is set to "0", then the limiting value is not sent at all.</p>
Cycl. Sending of limiting value 1 (x 10 s)	0...120	<p>Set whether and at what time interval the limiting value is sent here. The set value multiplied by 10 is the repeat time in seconds. It is thus possible to set the cycle time in step widths of 10 seconds. The value "0" indicates that the limiting value object is not transmitted cyclically.</p> <p>i If this parameter "Sending of limiting value for value change" is set to "No" and the parameter "Cyclic sending of the limiting value" is set to "0", then the limiting value is not sent at all.</p>

☐ Relative humidity limiting value 2 (Only visible if the parameter 'Relative humidity' under 'General' is set to 'Activated' and the parameter 'Limiting values' is set here to 'Limiting values 1 and 2 activated'!)

<p>Limiting value 2 in %</p>	<p>20 % 30 % 40 % 45 % 50 % 55 % 60 % 65 % 70 % 75 % 80 % 90 %</p>	<p>Set the threshold for the limiting value in the range from 20 to 90 % here.</p> <p>i In conjunction with the parameters "Limiting value 2" and "Hysteresis limiting value 2", define the thresholds at which the limiting value object is set to "1" or "0" when they are exceeded or undershot.</p>
<p>Hysteresis limiting value 2 in %</p>	<p>No hysteresis 10 % 15 % 20 %</p>	<p>Set here the hysteresis in the range from no hysteresis to 20 %.</p> <p>i In conjunction with the parameters "Limiting value 2" and "Activation of limiting value 2", define the thresholds at which the limiting value object is set to "1" or "0" when they are exceeded or fallen below.</p>
<p>Activation of limiting value 2 LV=Limiting value, Hyst.=Hysteresis</p>	<p>Exceed LV = ON, Undershoot LV - hyst. = OFF</p> <p>Exceed LV = OFF, Undershoot LV - hyst. = ON</p> <p>Undershoot LV = ON, Exceed LV + hyst. = OFF</p> <p>Undershoot LV = OFF, Exceed LV + hyst. = ON</p> <p>Exceed LV = ON, Undershoot LV hyst. = No telegr.</p> <p>Exceed LV = OFF, Undershoot LV hyst. = No telegr.</p> <p>Undershoot LV = ON, Exceed LV + hyst. = No telegr.</p> <p>Undershoot LV = OFF, Exceed LV + hyst. = No telegr.</p> <p>Exceed LV = No telegr., Undershoot LV hyst. = OFF</p> <p>Exceed LV = No telegr., Undershoot LV hyst. = ON</p>	<p>Here, it is possible to set which action is to be executed when the limiting value is crossed from an exactly defined direction.</p> <p>i In conjunction with the parameters "Limiting value 2" and "Hysteresis limiting value 2", define the thresholds at which the limiting value object is set to "1" or "0" when they are exceeded or undershot.</p>

	Undershoot LV = No teleg., Exceed LV + hyst. = OFF	
	Undershoot LV = No teleg., Exceed LV + hyst. = ON	
External limiting value 2	No	No external limiting value 2 is parametrized
	16 bit value	The limiting value is specified by an external device using a 2-byte value object.
	8 bit value	The limiting value is specified by an external device using a 1-byte value object.
Switch-on delay limiting value 2	No delay 1s delay 3s delay 5s delay 10s delay 15s delay 30s delay 1min delay 3min delay 5min delay 10min delay 15min delay 30min delay 60min delay	Only after the time set here will the current state of the limiting value be accepted in the limiting value object. This means that - a change in the limiting value to "1" will only be sent after this time elapses, - in the case of cyclic sending of the limiting value, the changed value "1" is only sent after this time expires. Therefore a "0" continues to be sent while the timer for the delay time is running. i If the parameter "Activation limiting value" for a condition is set to "No telegram", then the cyclic telegrams are also suppressed when the set condition is fulfilled.
Switch-off delay limiting value 2	No delay 1s delay 3s delay 5s delay 10s delay 15s delay 30s delay 1min delay 3min delay 5min delay 10min delay 15min delay 30min delay 60min delay	Only after the time set here will the current state of the limiting value be accepted in the limiting value object. This means that - a change in the limiting value to "0" will only be sent after this time elapses, - in the case of cyclic sending of the limiting value, the changed value "0" is only sent after this time expires. Therefore a "1" continues to be sent while the timer for the delay time is running. i If the parameter "Activation limiting value" for a condition is set to "No telegram", then the cyclic telegrams are also suppressed when the set condition is fulfilled.
Sending of limiting value 2 for value change	No	The limiting value object is not sent following a change. If the parameter "Cyclic sending of the limiting value" is set to at least 1, then the limiting value object is sent cyclically regardless of any change.
	Yes	The limiting value object is sent following a change from "0" to "1" or from "1" to "0".

Cycl. Sending of limiting value 2
(x 10 s) 0...120

- i** If this parameter "Sending of limiting value for value change" is set to "No" and the parameter "Cyclic sending of the limiting value" is set to "0", then the limiting value is not sent at all.

Set whether and at what time interval the limiting value is sent here. The set value multiplied by 10 is the repeat time in seconds. It is thus possible to set the cycle time in step widths of 10 seconds. The value "0" indicates that the limiting value object is not transmitted cyclically.

- i** If this parameter "Sending of limiting value for value change" is set to "No" and the parameter "Cyclic sending of the limiting value" is set to "0", then the limiting value is not sent at all.

4.2.4.13 Parameter group "Temperature sensor"

Description	Values	Comment
<input type="checkbox"/> Temperature sensor (Only visible if the parameter 'Temperature sensor' under 'General' is set to 'Activated') (Measuring range -30...60 °C)		
Limiting values	not activated Limiting value 1 activated Limiting values 1 and 2 activated	Select here whether this sensor should have limiting values, and how many. <input type="checkbox"/> Limiting values that are not activated will not be displayed!
Send measured value on (10 s send delay)	0.5% measured value difference 1% measured value difference 3% measured value difference 10% measured value difference	So as not to burden the bus with very frequent telegrams, the measured value should not be sent for every tiny change. While taking the measurement task into account, a maximum possible value should be set here. <input type="checkbox"/> The percentage specification for the measured value difference is always relative to the measuring range upper range value! <input type="checkbox"/> A fixed sending delay of 10 seconds is set.
Cycl. sending of the measured value (x 10 s)	0...120	Set here whether and at what time interval the value is sent. The set value multiplied by 10 is the repeat time in seconds. It is thus possible to set the cycle time in step widths of 10 seconds. The value "0" means that no cyclic sending is carried out. <input type="checkbox"/> The cyclic telegrams sent via this setting are independent of the telegrams resulting from the setting "Send measured value on... measured value difference".
<input type="checkbox"/> Temperature sensor limiting value 1 (Only visible if the parameter 'Temperature sensor' under 'General' is set to 'Activated' and the parameter 'Limiting values' is set here to 'Limiting value 1 activated' or to 'Limiting values 1 and 2 activated')		
Limiting value 1 in °C	-15 °C -10 °C -5 °C (23 °F) -4 °C -3 °C -2 °C -1 °C 0 °C (32 °F) 1 °C 2 °C 3 °C 4 °C 5 °C (41 °F) 6 °C 7 °C 8 °C 9 °C 10 °C (50 °F)	Set here the threshold for the limiting value in the range from -15 °C to +50 °C. <input type="checkbox"/> In conjunction with the parameters "Limiting value 1" and "Hysteresis limiting value 1", define the thresholds at which the limiting value object is set to "1" or "0" when they are exceeded or undershot.

	<p>11 °C 12 °C 13 °C 14 °C 15 °C (59 °F) 16 °C 17 °C 18 °C 19 °C 20 °C (68 °F) 21 °C 22 °C 23 °C 24 °C 25 °C (77 °F) 26 °C 27 °C 28 °C 29 °C 30 °C (86 °F) 31 °C 32 °C 33 °C 34 °C 35 °C (95 °F) 40 °C 45 °C 50 °C (122 °F)</p>	
Hysteresis limiting value 1 in K	<p>no hysteresis 1 K 2 K 3 K 4 K 5 K 10 K 15 K 20 K</p>	<p>Set the hysteresis in the range from no hysteresis to 20 K here.</p> <p>i In conjunction with the parameters "Limiting value 1" and "Activation of limiting value 1", define the thresholds at which the limiting value object is set to "1" or "0" when they are exceeded or fallen below.</p>
Activation of limiting value 1 LV=Limiting value, Hyst.=Hysteresis	<p>Exceed LV = ON, Undershoot LV - hyst. = OFF</p> <p>Exceed LV = OFF, Undershoot LV - hyst. = ON</p> <p>Undershoot LV = ON, Exceed LV + hyst. = OFF</p> <p>Undershoot LV = OFF, Exceed LV + hyst. = ON</p> <p>Exceed LV = ON, Undershoot LV hyst. = No telegr.</p> <p>Exceed LV = OFF, Undershoot LV hyst. = No telegr.</p> <p>Undershoot LV = ON, Exceed LV + hyst. = No telegr.</p>	<p>Here, it is possible to set which action is to be executed when the limiting value is crossed from an exactly defined direction.</p> <p>i In conjunction with the parameters "Limiting value 1" and "Hysteresis limiting value 1", define the thresholds at which the limiting value object is set to "1" or "0" when they are exceeded or undershot.</p>

	Undershoot LV = OFF, Exceed LV + hyst. = No telegr.	
	Exceed LV = No telegr., Undershoot LV hyst. = OFF	
	Exceed LV = No telegr., Undershoot LV hyst. = ON	
	Undershoot LV = No telegr., Exceed LV + hyst. = OFF	
	Undershoot LV = No telegr., Exceed LV + hyst. = ON	
External limiting value 1	No	No external limiting value 1 is parametrized
	16 bit value	The limiting value is specified by an external device using a 2-byte value object.
	8 bit value	The limiting value is specified by an external device using a 1-byte value object.
	Save limiting value via switching obj. (teaching)	When this external switching object is used, the current measured value of the sensor can be defined as limiting value, e.g. by a button-press.
		<ul style="list-style-type: none"> i Using an external object, the user of the building can set the limiting value to suit their needs, without having to change the configuration. i During a download, the external values are overwritten with the ETS data. Only when a value is again received after a download is this value processed again.
Switch-on delay limiting value 1	No delay 1s delay 3s delay 5s delay 10s delay 15s delay 30s delay 1min delay 3min delay 5min delay 10min delay 15min delay 30min delay 60min delay	<p>Only after the time set here will the current state of the limiting value be accepted in the limiting value object. This means that</p> <ul style="list-style-type: none"> - a change in the limiting value to "1" will only be sent after this time elapses, - in the case of cyclic sending of the limiting value, the changed value "1" is only sent after this time expires. <p>Therefore a "0" continues to be sent while the timer for the delay time is running.</p> <ul style="list-style-type: none"> i If the parameter "Activation limiting value" for a condition is set to "No telegram", then the cyclic telegrams are also suppressed when the set condition is fulfilled.
Switch-off delay limiting value 1	No delay 1s delay	Only after the time set here will the current state of the limiting value be

	<p>3s delay 5s delay 10s delay 15s delay 30s delay 1min delay 3min delay 5min delay 10min delay 15min delay 30min delay 60min delay</p>	<p>accepted in the limiting value object. This means that</p> <ul style="list-style-type: none"> - a change in the limiting value to "0" will only be sent after this time elapses, - in the case of cyclic sending of the limiting value, the changed value "0" is only sent after this time expires. <p>Therefore a "1" continues to be sent while the timer for the delay time is running.</p> <p>i If the parameter "Activation limiting value" for a condition is set to "No telegram", then the cyclic telegrams are also suppressed when the set condition is fulfilled.</p>
Sending of limiting value 1 for value change	No	<p>The limiting value object is not sent following a change. If the parameter "Cyclic sending of the limiting value" is set to at least 1, then the limiting value object is sent cyclically regardless of any change.</p>
	Yes	<p>The limiting value object is sent following a change from "0" to "1" or from "1" to "0".</p> <p>i If this parameter "Sending of limiting value for value change" is set to "No" and the parameter "Cyclic sending of the limiting value" is set to "0", then the limiting value is not sent at all.</p>
Cycl. Sending of limiting value 1 (x 10 s)	0...120	<p>Set whether and at what time interval the limiting value is sent here. The set value multiplied by 10 is the repeat time in seconds. It is thus possible to set the cycle time in step widths of 10 seconds. The value "0" indicates that the limiting value object is not transmitted cyclically.</p> <p>i If this parameter "Sending of limiting value for value change" is set to "No" and the parameter "Cyclic sending of the limiting value" is set to "0", then the limiting value is not sent at all.</p>
<p><input type="checkbox"/> Temperature sensor limiting value 2 (Only visible if the parameter 'Temperature sensor' under 'General' is set to 'Activated' and the parameter 'Limiting values' is set here to 'Limiting values 1 and 2 activated!')</p>		
Limiting value 2 in °C	<p>-15 °C -10 °C -5 °C (23 °F) -4 °C -3 °C -2 °C -1 °C 0 °C (32 °F) 1 °C 2 °C 3 °C</p>	<p>Set here the threshold for the limiting value in the range from -15 °C to +50 °C.</p> <p>i In conjunction with the parameters "Limiting value 2" and "Hysteresis limiting value 2", define the thresholds at which the limiting value object is set to "1" or "0" when they are exceeded or undershot.</p>

- 4 °C
- 5 °C (41 °F)
- 6 °C
- 7 °C
- 8 °C
- 9 °C
- 10 °C (50 °F)
- 11 °C
- 12 °C
- 13 °C
- 14 °C
- 15 °C (59 °F)
- 16 °C
- 17 °C
- 18 °C
- 19 °C
- 20 °C (68 °F)
- 21 °C
- 22 °C
- 23 °C
- 24 °C
- 25 °C (77 °F)**
- 26 °C
- 27 °C
- 28 °C
- 29 °C
- 30 °C (86 °F)
- 31 °C
- 32 °C
- 33 °C
- 34 °C
- 35 °C (95 °F)
- 40 °C
- 45 °C
- 50 °C (122 °F)

Hysteresis limiting value
2 in K

- no hysteresis
- 1 K
- 2 K
- 3 K
- 4 K
- 5 K**
- 10 K
- 15 K
- 20 K

Set the hysteresis in the range from no hysteresis to 20 K here.

i In conjunction with the parameters "Limiting value 2" and "Activation of limiting value 2", define the thresholds at which the limiting value object is set to "1" or "0" when they are exceeded or fallen below.

Activation of limiting
value 2
LV=Limiting value,
Hyst.=Hysteresis

**Exceed LV = ON,
Undershoot LV - hyst. =
OFF**

Here, it is possible to set which action is to be executed when the limiting value is crossed from an exactly defined direction.

Exceed LV = OFF,
Undershoot LV - hyst. = ON

i In conjunction with the parameters "Limiting value 2" and "Hysteresis limiting value 2", define the thresholds at which the limiting value object is set to "1" or "0" when they are exceeded or undershot.

Undershoot LV = ON,
Exceed LV + hyst. = OFF

Undershoot LV = OFF,
Exceed LV + hyst. = ON

Exceed LV = ON,
Undershoot LV hyst. =
No telegr.

	Exceed LV = OFF, Undershoot LV hyst. = No telegr.	
	Undershoot LV = ON, Exceed LV + hyst. = No telegr.	
	Undershoot LV = OFF, Exceed LV + hyst. = No telegr.	
	Exceed LV = No telegr., Undershoot LV hyst. = OFF	
	Exceed LV = No telegr., Undershoot LV hyst. = ON	
	Undershoot LV = No telegr., Exceed LV + hyst. = OFF	
	Undershoot LV = No telegr., Exceed LV + hyst. = ON	
External limiting value 2	No	No external limiting value 2 is parametrized
	16 bit value	The limiting value is specified by an external device using a 2-byte value object.
	8 bit value	The limiting value is specified by an external device using a 1-byte value object.
	Save limiting value via switching obj. (teaching)	When this external switching object is used, the current measured value of the sensor can be defined as limiting value, e.g. by a button-press.
		<ul style="list-style-type: none"> i Using an external object, the user of the building can set the limiting value to suit their needs, without having to change the configuration. i During a download, the external values are overwritten with the ETS data. Only when a value is again received after a download is this value processed again.
Switch-on delay limiting value 2	No delay 1s delay 3s delay 5s delay 10s delay 15s delay 30s delay 1min delay 3min delay 5min delay 10min delay 15min delay	Only after the time set here will the current state of the limiting value be accepted in the limiting value object. This means that <ul style="list-style-type: none"> - a change in the limiting value to "1" will only be sent after this time elapses, - in the case of cyclic sending of the limiting value, the changed value "1" is only sent after this time expires. Therefore a "0" continues to be sent while the timer for the delay time is running.

	30min delay 60min delay	<p>i If the parameter "Activation limiting value" for a condition is set to "No telegram", then the cyclic telegrams are also suppressed when the set condition is fulfilled.</p>
Switch-off delay limiting value 2	No delay 1s delay 3s delay 5s delay 10s delay 15s delay 30s delay 1min delay 3min delay 5min delay 10min delay 15min delay 30min delay 60min delay	<p>Only after the time set here will the current state of the limiting value be accepted in the limiting value object. This means that</p> <ul style="list-style-type: none"> - a change in the limiting value to "0" will only be sent after this time elapses, - in the case of cyclic sending of the limiting value, the changed value "0" is only sent after this time expires. <p>Therefore a "1" continues to be sent while the timer for the delay time is running.</p> <p>i If the parameter "Activation limiting value" for a condition is set to "No telegram", then the cyclic telegrams are also suppressed when the set condition is fulfilled.</p>
Sending of limiting value 2 for value change	No	<p>The limiting value object is not sent following a change. If the parameter "Cyclic sending of the limiting value" is set to at least 1, then the limiting value object is sent cyclically regardless of any change.</p>
	Yes	<p>The limiting value object is sent following a change from "0" to "1" or from "1" to "0".</p> <p>i If this parameter "Sending of limiting value for value change" is set to "No" and the parameter "Cyclic sending of the limiting value" is set to "0", then the limiting value is not sent at all.</p>
Cycl. Sending of limiting value 2 (x 10 s)	0...120	<p>Set whether and at what time interval the limiting value is sent here. The set value multiplied by 10 is the repeat time in seconds. It is thus possible to set the cycle time in step widths of 10 seconds. The value "0" indicates that the limiting value object is not transmitted cyclically.</p> <p>i If this parameter "Sending of limiting value for value change" is set to "No" and the parameter "Cyclic sending of the limiting value" is set to "0", then the limiting value is not sent at all.</p>

4.2.4.14 Parameter group "Felt temperature"

Description	Values	Comment
<input type="checkbox"/> Felt temperature (Only visible if the parameter 'Felt temperature' under 'General' is set to 'Activated!') (Measuring range -30...60 °C)		
Limiting values	not activated Limiting value 1 activated Limiting values 1 and 2 activated	Select here whether this sensor should have limiting values, and how many. <input type="checkbox"/> Limiting values that are not activated will not be displayed!
Send measured value on (10 s send delay)	0.5% measured value difference 1% measured value difference 3% measured value difference 10% measured value difference	So as not to burden the bus with very frequent telegrams, the measured value should not be sent for every tiny change. While taking the measurement task into account, a maximum possible value should be set here. <input type="checkbox"/> The percentage specification for the measured value difference is always relative to the measuring range upper range value! <input type="checkbox"/> A fixed sending delay of 10 seconds is set.
Cycl. sending of the measured value (x 10 s)	0...120	Set here whether and at what time interval the value is sent. The set value multiplied by 10 is the repeat time in seconds. It is thus possible to set the cycle time in step widths of 10 seconds. The value "0" means that no cyclic sending is carried out. <input type="checkbox"/> The cyclic telegrams sent via this setting are independent of the telegrams resulting from the setting "Send measured value on... measured value difference".
<input type="checkbox"/> Felt temperature limiting value 1 (Only visible if the parameter 'Felt temperature' under 'General' is set to 'Activated' and the parameter 'Limiting values' is set here to 'Limiting value 1 activated' or to 'Limiting values 1 and 2 activated!')		
Limiting value 1 in °C	-15 °C -10 °C -5 °C (23 °F) -4 °C -3 °C -2 °C -1 °C 0 °C (32 °F) 1 °C 2 °C 3 °C 4 °C 5 °C (41 °F) 6 °C 7 °C 8 °C 9 °C 10 °C (50 °F)	Set here the threshold for the limiting value in the range from -15 °C to +50 °C. <input type="checkbox"/> In conjunction with the parameters "Limiting value 1" and "Hysteresis limiting value 1", define the thresholds at which the limiting value object is set to "1" or "0" when they are exceeded or undershot.

	<p>11 °C 12 °C 13 °C 14 °C 15 °C (59 °F) 16 °C 17 °C 18 °C 19 °C 20 °C (68 °F) 21 °C 22 °C 23 °C 24 °C 25 °C (77 °F) 26 °C 27 °C 28 °C 29 °C 30 °C (86 °F) 31 °C 32 °C 33 °C 34 °C 35 °C (95 °F) 40 °C 45 °C 50 °C (122 °F)</p>	
<p>Hysteresis limiting value 1 in K</p>	<p>no hysteresis 1 K 2 K 3 K 4 K 5 K 10 K 15 K 20 K</p>	<p>Set the hysteresis in the range from no hysteresis to 20 K here.</p> <p>i In conjunction with the parameters "Limiting value 1" and "Activation of limiting value 1", define the thresholds at which the limiting value object is set to "1" or "0" when they are exceeded or fallen below.</p>
<p>Activation of limiting value 1 LV=Limiting value, Hyst.=Hysteresis</p>	<p>Exceed LV = ON, Undershoot LV - hyst. = OFF</p> <p>Exceed LV = OFF, Undershoot LV - hyst. = ON</p> <p>Undershoot LV = ON, Exceed LV + hyst. = OFF</p> <p>Undershoot LV = OFF, Exceed LV + hyst. = ON</p> <p>Exceed LV = ON, Undershoot LV hyst. = No telegr.</p> <p>Exceed LV = OFF, Undershoot LV hyst. = No telegr.</p> <p>Undershoot LV = ON, Exceed LV + hyst. = No telegr.</p>	<p>Here, it is possible to set which action is to be executed when the limiting value is crossed from an exactly defined direction.</p> <p>i In conjunction with the parameters "Limiting value 1" and "Hysteresis limiting value 1", define the thresholds at which the limiting value object is set to "1" or "0" when they are exceeded or undershot.</p>

	Undershoot LV = OFF, Exceed LV + hyst. = No telegr.	
	Exceed LV = No telegr., Undershoot LV hyst. = OFF	
	Exceed LV = No telegr., Undershoot LV hyst. = ON	
	Undershoot LV = No telegr., Exceed LV + hyst. = OFF	
	Undershoot LV = No telegr., Exceed LV + hyst. = ON	
External limiting value 1	No	No external limiting value 1 is parametrized
	16 bit value	The limiting value is specified by an external device using a 2-byte value object.
	8 bit value	The limiting value is specified by an external device using a 1-byte value object.
	Save limiting value via switching obj. (teaching)	When this external switching object is used, the current measured value of the sensor can be defined as limiting value, e.g. by a button-press.
		<ul style="list-style-type: none"> i Using an external object, the user of the building can set the limiting value to suit their needs, without having to change the configuration. i During a download, the external values are overwritten with the ETS data. Only when a value is again received after a download is this value processed again.
Switch-on delay limiting value 1	No delay 1s delay 3s delay 5s delay 10s delay 15s delay 30s delay 1min delay 3min delay 5min delay 10min delay 15min delay 30min delay 60min delay	<p>Only after the time set here will the current state of the limiting value be accepted in the limiting value object. This means that</p> <ul style="list-style-type: none"> - a change in the limiting value to "1" will only be sent after this time elapses, - in the case of cyclic sending of the limiting value, the changed value "1" is only sent after this time expires. <p>Therefore a "0" continues to be sent while the timer for the delay time is running.</p> <ul style="list-style-type: none"> i If the parameter "Activation limiting value" for a condition is set to "No telegram", then the cyclic telegrams are also suppressed when the set condition is fulfilled.
Switch-off delay limiting value 1	No delay 1s delay	Only after the time set here will the current state of the limiting value be

	<p>3s delay 5s delay 10s delay 15s delay 30s delay 1min delay 3min delay 5min delay 10min delay 15min delay 30min delay 60min delay</p>	<p>accepted in the limiting value object. This means that</p> <ul style="list-style-type: none"> - a change in the limiting value to "0" will only be sent after this time elapses, - in the case of cyclic sending of the limiting value, the changed value "0" is only sent after this time expires. <p>Therefore a "1" continues to be sent while the timer for the delay time is running.</p> <p>i If the parameter "Activation limiting value" for a condition is set to "No telegram", then the cyclic telegrams are also suppressed when the set condition is fulfilled.</p>
Sending of limiting value 1 for value change	No	<p>The limiting value object is not sent following a change. If the parameter "Cyclic sending of the limiting value" is set to at least 1, then the limiting value object is sent cyclically regardless of any change.</p>
	Yes	<p>The limiting value object is sent following a change from "0" to "1" or from "1" to "0".</p> <p>i If this parameter "Sending of limiting value for value change" is set to "No" and the parameter "Cyclic sending of the limiting value" is set to "0", then the limiting value is not sent at all.</p>
Cycl. Sending of limiting value 1 (x 10 s)	0...120	<p>Set whether and at what time interval the limiting value is sent here. The set value multiplied by 10 is the repeat time in seconds. It is thus possible to set the cycle time in step widths of 10 seconds. The value "0" indicates that the limiting value object is not transmitted cyclically.</p> <p>i If this parameter "Sending of limiting value for value change" is set to "No" and the parameter "Cyclic sending of the limiting value" is set to "0", then the limiting value is not sent at all.</p>
<p><input type="checkbox"/> Felt temperature limiting value 2 (Only visible if the parameter 'Felt temperature' under 'General' is set to 'Activated' and the parameter 'Limiting values' is set here to 'Limiting values 1 and 2 activated'!)</p>		
Limiting value 2 in °C	<p>-15 °C -10 °C -5 °C (23 °F) -4 °C -3 °C -2 °C -1 °C 0 °C (32 °F) 1 °C 2 °C 3 °C</p>	<p>Set here the threshold for the limiting value in the range from -15 °C to +50 °C.</p> <p>i In conjunction with the parameters "Limiting value 2" and "Hysteresis limiting value 2", define the thresholds at which the limiting value object is set to "1" or "0" when they are exceeded or undershot.</p>

- 4 °C
- 5 °C (41 °F)
- 6 °C
- 7 °C
- 8 °C
- 9 °C
- 10 °C (50 °F)
- 11 °C
- 12 °C
- 13 °C
- 14 °C
- 15 °C (59 °F)
- 16 °C
- 17 °C
- 18 °C**
- 19 °C
- 20 °C (68 °F)
- 21 °C
- 22 °C
- 23 °C
- 24 °C
- 25 °C (77 °F)
- 26 °C
- 27 °C
- 28 °C
- 29 °C
- 30 °C (86 °F)
- 31 °C
- 32 °C
- 33 °C
- 34 °C
- 35 °C (95 °F)
- 40 °C
- 45 °C
- 50 °C (122 °F)

Hysteresis limiting value
2 in K

- no hysteresis
- 1 K
- 2 K**
- 3 K
- 4 K
- 5 K
- 10 K
- 15 K
- 20 K

Set the hysteresis in the range from no hysteresis to 20 K here.

i In conjunction with the parameters "Limiting value 2" and "Activation of limiting value 2", define the thresholds at which the limiting value object is set to "1" or "0" when they are exceeded or fallen below.

Activation of limiting
value 2
LV=Limiting value,
Hyst.=Hysteresis

**Exceed LV = ON,
Undershoot LV - hyst. =
OFF**

Here, it is possible to set which action is to be executed when the limiting value is crossed from an exactly defined direction.

Exceed LV = OFF,
Undershoot LV - hyst. = ON

i In conjunction with the parameters "Limiting value 2" and "Hysteresis limiting value 2", define the thresholds at which the limiting value object is set to "1" or "0" when they are exceeded or undershot.

Undershoot LV = ON,
Exceed LV + hyst. = OFF

Undershoot LV = OFF,
Exceed LV + hyst. = ON

Exceed LV = ON,
Undershoot LV hyst. =
No telegr.

	Exceed LV = OFF, Undershoot LV hyst. = No telegr.	
	Undershoot LV = ON, Exceed LV + hyst. = No telegr.	
	Undershoot LV = OFF, Exceed LV + hyst. = No telegr.	
	Exceed LV = No telegr., Undershoot LV hyst. = OFF	
	Exceed LV = No telegr., Undershoot LV hyst. = ON	
	Undershoot LV = No telegr., Exceed LV + hyst. = OFF	
	Undershoot LV = No telegr., Exceed LV + hyst. = ON	
External limiting value 2	No	No external limiting value 2 is parametrized
	16 bit value	The limiting value is specified by an external device using a 2-byte value object.
	8 bit value	The limiting value is specified by an external device using a 1-byte value object.
	Save limiting value via switching obj. (teaching)	When this external switching object is used, the current measured value of the sensor can be defined as limiting value, e.g. by a button-press.
		<ul style="list-style-type: none"> i Using an external object, the user of the building can set the limiting value to suit their needs, without having to change the configuration. i During a download, the external values are overwritten with the ETS data. Only when a value is again received after a download is this value processed again.
Switch-on delay limiting value 2	No delay 1s delay 3s delay 5s delay 10s delay 15s delay 30s delay 1min delay 3min delay 5min delay 10min delay 15min delay	Only after the time set here will the current state of the limiting value be accepted in the limiting value object. This means that <ul style="list-style-type: none"> - a change in the limiting value to "1" will only be sent after this time elapses, - in the case of cyclic sending of the limiting value, the changed value "1" is only sent after this time expires. Therefore a "0" continues to be sent while the timer for the delay time is running.

	30min delay 60min delay	<p>i If the parameter "Activation limiting value" for a condition is set to "No telegram", then the cyclic telegrams are also suppressed when the set condition is fulfilled.</p>
Switch-off delay limiting value 2	No delay 1s delay 3s delay 5s delay 10s delay 15s delay 30s delay 1min delay 3min delay 5min delay 10min delay 15min delay 30min delay 60min delay	<p>Only after the time set here will the current state of the limiting value be accepted in the limiting value object. This means that</p> <ul style="list-style-type: none"> - a change in the limiting value to "0" will only be sent after this time elapses, - in the case of cyclic sending of the limiting value, the changed value "0" is only sent after this time expires. <p>Therefore a "1" continues to be sent while the timer for the delay time is running.</p> <p>i If the parameter "Activation limiting value" for a condition is set to "No telegram", then the cyclic telegrams are also suppressed when the set condition is fulfilled.</p>
Sending of limiting value 2 for value change	No	<p>The limiting value object is not sent following a change. If the parameter "Cyclic sending of the limiting value" is set to at least 1, then the limiting value object is sent cyclically regardless of any change.</p>
	Yes	<p>The limiting value object is sent following a change from "0" to "1" or from "1" to "0".</p> <p>i If this parameter "Sending of limiting value for value change" is set to "No" and the parameter "Cyclic sending of the limiting value" is set to "0", then the limiting value is not sent at all.</p>
Cycl. Sending of limiting value 2 (x 10 s)	0...120	<p>Set whether and at what time interval the limiting value is sent here. The set value multiplied by 10 is the repeat time in seconds. It is thus possible to set the cycle time in step widths of 10 seconds. The value "0" indicates that the limiting value object is not transmitted cyclically.</p> <p>i If this parameter "Sending of limiting value for value change" is set to "No" and the parameter "Cyclic sending of the limiting value" is set to "0", then the limiting value is not sent at all.</p>

4.2.4.15 Parameter group "Comfort"

Description	Values	Comment
<input type="checkbox"/> Comfort (Only visible if the parameter 'Comfort' under 'General' is set to 'Activated!')		
Cycl. sending of the oppressiveness measured value (x 10 s)	0...120	<p>Set here whether and at what time interval the value is sent. The set value multiplied by 10 is the repeat time in seconds. It is thus possible to set the cycle time in step widths of 10 seconds. The value "0" means that no cyclic sending is carried out.</p> <p>i The cyclic telegrams sent via this setting are independent of the telegrams resulting from the setting "Send measured value on... measured value difference".</p>
Cycl. sending of the comfort measured value (x 10 s)	0...120	<p>Set here whether and at what time interval the value is sent. The set value multiplied by 10 is the repeat time in seconds. It is thus possible to set the cycle time in step widths of 10 seconds. The value "0" means that no cyclic sending is carried out.</p> <p>i The cyclic telegrams sent via this setting are independent of the telegrams resulting from the setting "Send measured value on... measured value difference".</p>
Transmit the oppressiveness measured value on change	No	The value object is not sent following a change.
	Yes	The value object is sent following a change from "0" to "1" or from "1" to "0".
Sending of comfort value on value change	No	The value object is not sent following a change.
	Yes	The value object is sent following a change from "0" to "1" or from "1" to "0".
Adjustment of the tolerance range	Level 1: Sensitive Level 2 Level 3: Standard Level 4 Level 5: Insensitive	This parameter defines the sensitivity of the measurement of comfort and oppressiveness.

4.2.4.16 Parameter group "Air pressure"

Description	Values	Comment
<input type="checkbox"/> Air pressure (Only visible if the parameter 'Air pressure' under 'General' is set to 'Activated!') (Measuring range 300...1100 hPa)		
Limiting values	not activated Limiting value 1 activated Limiting values 1 and 2 activated	Select here whether this sensor should have limiting values, and how many. i Limiting values that are not activated will not be displayed!
Send measured value on (10 s send delay)	0.5% measured value difference 1% measured value difference 3% measured value difference 10% measured value difference	So as not to burden the bus with very frequent telegrams, the measured value should not be sent for every tiny change. While taking the measurement task into account, a maximum possible value should be set here. i The percentage specification for the measured value difference is always relative to the measuring range upper range value! i A fixed sending delay of 10 seconds is set.
Cycl. sending of the measured value (x 10 s)	0 ...120	Set here whether and at what time interval the value is sent. The set value multiplied by 10 is the repeat time in seconds. It is thus possible to set the cycle time in step widths of 10 seconds. The value "0" means that no cyclic sending is carried out. i The cyclic telegrams sent via this setting are independent of the telegrams resulting from the setting "Send measured value on... measured value difference".
<input type="checkbox"/> Air pressure limiting value 1 (Only visible if the parameter 'Air pressure' under 'General' is set to 'Activated' and the parameter 'Limiting values' is set here to 'Limiting value 1 activated' or to 'Limiting values 1 and 2 activated!')		
Limiting value 1 in hPa	900 hPa 990 hPa 995 hPa 1000 hPa 1005 hPa 1010 hPa 1015 hPa 1020 hPa 1025 hPa 1030 hPa 1035 hPa 1100 hPa	Set the threshold for the limiting value in the range from 900 to 1100 hPa here. i In conjunction with the parameters "Limiting value 1" and "Hysteresis limiting value 1", define the thresholds at which the limiting value object is set to "1" or "0" when they are exceeded or undershot.
Hysteresis limiting value 1 in hPa	No hysteresis 0.3 hPa 0.5 hPa 1 hPa 3 hPa	Set here the hysteresis in the range from no hysteresis to 5 hPa.

Activation of limiting value 1 LV=Limiting value, Hyst.=Hysteresis	<p>5 hPa</p> <p>Exceed LV = ON, Undershoot LV - hyst. = OFF</p> <p>Exceed LV = OFF, Undershoot LV - hyst. = ON</p> <p>Undershoot LV = ON, Exceed LV + hyst. = OFF</p> <p>Undershoot LV = OFF, Exceed LV + hyst. = ON</p> <p>Exceed LV = ON, Undershoot LV hyst. = No telegr.</p> <p>Exceed LV = OFF, Undershoot LV hyst. = No telegr.</p> <p>Undershoot LV = ON, Exceed LV + hyst. = No telegr.</p> <p>Undershoot LV = OFF, Exceed LV + hyst. = No telegr.</p> <p>Exceed LV = No telegr., Undershoot LV hyst. = OFF</p> <p>Exceed LV = No telegr., Undershoot LV hyst. = ON</p> <p>Undershoot LV = No telegr., Exceed LV + hyst. = OFF</p> <p>Undershoot LV = No telegr., Exceed LV + hyst. = ON</p>	<p>i In conjunction with the parameters "Limiting value 1" and "Activation of limiting value 1", define the thresholds at which the limiting value object is set to "1" or "0" when they are exceeded or fallen below.</p> <p>Here, it is possible to set which action is to be executed when the limiting value is crossed from an exactly defined direction.</p> <p>i In conjunction with the parameters "Limiting value 1" and "Hysteresis limiting value 1", define the thresholds at which the limiting value object is set to "1" or "0" when they are exceeded or undershot.</p>
External limiting value 1	No	No external limiting value 1 is parametrized
	16 bit value	The limiting value is specified by an external device using a 2-byte value object.
	8 bit value	The limiting value is specified by an external device using a 1-byte value object.
Switch-on delay limiting value 1	No delay 1s delay 3s delay	Only after the time set here will the current state of the limiting value be accepted in the limiting value object.

	5s delay 10s delay 15s delay 30s delay 1min delay 3min delay 5min delay 10min delay 15min delay 30min delay 60min delay	<p>This means that</p> <ul style="list-style-type: none"> - a change in the limiting value to "1" will only be sent after this time elapses, - in the case of cyclic sending of the limiting value, the changed value "1" is only sent after this time expires. <p>Therefore a "0" continues to be sent while the timer for the delay time is running.</p> <p>i If the parameter "Activation limiting value" for a condition is set to "No telegram", then the cyclic telegrams are also suppressed when the set condition is fulfilled.</p>
Switch-off delay limiting value 1	No delay 1s delay 3s delay 5s delay 10s delay 15s delay 30s delay 1min delay 3min delay 5min delay 10min delay 15min delay 30min delay 60min delay	<p>Only after the time set here will the current state of the limiting value be accepted in the limiting value object.</p> <p>This means that</p> <ul style="list-style-type: none"> - a change in the limiting value to "0" will only be sent after this time elapses, - in the case of cyclic sending of the limiting value, the changed value "0" is only sent after this time expires. <p>Therefore a "1" continues to be sent while the timer for the delay time is running.</p> <p>i If the parameter "Activation limiting value" for a condition is set to "No telegram", then the cyclic telegrams are also suppressed when the set condition is fulfilled.</p>
Sending of limiting value 1 for value change	<p>No</p> <p>Yes</p>	<p>The limiting value object is not sent following a change.</p> <p>If the parameter "Cyclic sending of the limiting value" is set to at least 1, then the limiting value object is sent cyclically regardless of any change.</p> <p>The limiting value object is sent following a change from "0" to "1" or from "1" to "0".</p> <p>i If this parameter "Sending of limiting value for value change" is set to "No" and the parameter "Cyclic sending of the limiting value" is set to "0", then the limiting value is not sent at all.</p>
Cycl. Sending of limiting value 1 (x 10 s)	0...120	<p>Set whether and at what time interval the limiting value is sent here. The set value multiplied by 10 is the repeat time in seconds. It is thus possible to set the cycle time in step widths of 10 seconds. The value "0" indicates that the limiting value object is not transmitted cyclically.</p> <p>i If this parameter "Sending of limiting value for value change" is set to "No" and the parameter "Cyclic sending of the limiting value" is set to "0", then the limiting value is not sent at all.</p>

☐ Air pressure limiting value 2 (Only visible if the parameter 'Air pressure' under 'General' is set to 'Activated' and the parameter 'Limiting values' is set here to 'Limiting values 1 and 2 activated!')

<p>Limiting value 2 in hPa</p>	<p>900 hPa 990 hPa 995 hPa 1000 hPa 1005 hPa 1010 hPa 1015 hPa 1020 hPa 1025 hPa 1030 hPa 1035 hPa 1100 hPa</p>	<p>Set the threshold for the limiting value in the range from 900 to 1100 hPa here.</p> <p>i In conjunction with the parameters "Limiting value 2" and "Hysteresis limiting value 2", define the thresholds at which the limiting value object is set to "1" or "0" when they are exceeded or undershot.</p>
<p>Hysteresis limiting value 2 in hPa</p>	<p>No hysteresis 0.3 hPa 0.5 hPa 1 hPa 3 hPa 5 hPa</p>	<p>Set here the hysteresis in the range from no hysteresis to 5 hPa.</p> <p>i In conjunction with the parameters "Limiting value 2" and "Activation of limiting value 2", define the thresholds at which the limiting value object is set to "1" or "0" when they are exceeded or fallen below.</p>
<p>Activation of limiting value 2 LV=Limiting value, Hyst.=Hysteresis</p>	<p>Exceed LV = ON, Undershoot LV - hyst. = OFF</p> <p>Exceed LV = OFF, Undershoot LV - hyst. = ON</p> <p>Undershoot LV = ON, Exceed LV + hyst. = OFF</p> <p>Undershoot LV = OFF, Exceed LV + hyst. = ON</p> <p>Exceed LV = ON, Undershoot LV hyst. = No telegr.</p> <p>Exceed LV = OFF, Undershoot LV hyst. = No telegr.</p> <p>Undershoot LV = ON, Exceed LV + hyst. = No telegr.</p> <p>Undershoot LV = OFF, Exceed LV + hyst. = No telegr.</p> <p>Exceed LV = No telegr., Undershoot LV hyst. = OFF</p> <p>Exceed LV = No telegr., Undershoot LV hyst. = ON</p>	<p>Here, it is possible to set which action is to be executed when the limiting value is crossed from an exactly defined direction.</p> <p>i In conjunction with the parameters "Limiting value 2" and "Hysteresis limiting value 2", define the thresholds at which the limiting value object is set to "1" or "0" when they are exceeded or undershot.</p>

	Undershoot LV = No teleg., Exceed LV + hyst. = OFF	
	Undershoot LV = No teleg., Exceed LV + hyst. = ON	
External limiting value 2	No	No external limiting value 2 is parametrized
	16 bit value	The limiting value is specified by an external device using a 2-byte value object.
	8 bit value	The limiting value is specified by an external device using a 1-byte value object.
Switch-on delay limiting value 2	No delay 1s delay 3s delay 5s delay 10s delay 15s delay 30s delay 1min delay 3min delay 5min delay 10min delay 15min delay 30min delay 60min delay	Only after the time set here will the current state of the limiting value be accepted in the limiting value object. This means that - a change in the limiting value to "1" will only be sent after this time elapses, - in the case of cyclic sending of the limiting value, the changed value "1" is only sent after this time expires. Therefore a "0" continues to be sent while the timer for the delay time is running.
		i If the parameter "Activation limiting value" for a condition is set to "No telegram", then the cyclic telegrams are also suppressed when the set condition is fulfilled.
Switch-off delay limiting value 2	No delay 1s delay 3s delay 5s delay 10s delay 15s delay 30s delay 1min delay 3min delay 5min delay 10min delay 15min delay 30min delay 60min delay	Only after the time set here will the current state of the limiting value be accepted in the limiting value object. This means that - a change in the limiting value to "0" will only be sent after this time elapses, - in the case of cyclic sending of the limiting value, the changed value "0" is only sent after this time expires. Therefore a "1" continues to be sent while the timer for the delay time is running.
		i If the parameter "Activation limiting value" for a condition is set to "No telegram", then the cyclic telegrams are also suppressed when the set condition is fulfilled.
Sending of limiting value 2 for value change	No	The limiting value object is not sent following a change. If the parameter "Cyclic sending of the limiting value" is set to at least 1, then the limiting value object is sent cyclically regardless of any change.
	Yes	

Cycl. Sending of limiting value 2
(x 10 s) 0...120

The limiting value object is sent following a change from "0" to "1" or from "1" to "0".

i If this parameter "Sending of limiting value for value change" is set to "No" and the parameter "Cyclic sending of the limiting value" is set to "0", then the limiting value is not sent at all.

Set whether and at what time interval the limiting value is sent here. The set value multiplied by 10 is the repeat time in seconds. It is thus possible to set the cycle time in step widths of 10 seconds. The value "0" indicates that the limiting value object is not transmitted cyclically.

i If this parameter "Sending of limiting value for value change" is set to "No" and the parameter "Cyclic sending of the limiting value" is set to "0", then the limiting value is not sent at all.

4.2.4.17 Parameter group "Global radiation"

Description	Values	Comment
<input type="checkbox"/> Global radiation (Only visible if the parameter 'Global radiation' under 'General' is set to 'Activated!')		
Limiting values	not activated Limiting value 1 activated Limiting values 1 and 2 activated	Select here whether this sensor should have limiting values, and how many. i Limiting values that are not activated will not be displayed!
Send measured value on (10 s send delay)	0.5% measured value difference 1% measured value difference 3% measured value difference 10% measured value difference	So as not to burden the bus with very frequent telegrams, the measured value should not be sent for every tiny change. While taking the measurement task into account, a maximum possible value should be set here. i The percentage specification for the measured value difference is always relative to the measuring range upper range value! i A fixed sending delay of 10 seconds is set.
Cycl. sending of the measured value (x 10 s)	0...120	Set here whether and at what time interval the value is sent. The set value multiplied by 10 is the repeat time in seconds. It is thus possible to set the cycle time in step widths of 10 seconds. The value "0" means that no cyclic sending is carried out. i The cyclic telegrams sent via this setting are independent of the telegrams resulting from the setting "Send measured value on... measured value difference".
<input type="checkbox"/> Global radiation limiting value 1 (Only visible if the parameter 'Global radiation' under 'General' is set to 'Activated' and the parameter 'Limiting values' is set here to 'Limiting value 1 activated' or to 'Limiting values 1 and 2 activated!')		
Limiting value 1 in W/m ²	300 Watt/m ² 400 Watt/m ² 500 Watt/m ² 600 Watt/m ² 700 Watt/m ² 800 Watt/m ² 900 Watt/m² 1000 Watt/m ² 1100 Watt/m ² 1200 Watt/m ² 1300 Watt/m ²	Set the threshold for the limiting value in the range from 300 to 1300 W/m ² here. i In conjunction with the parameters "Limiting value 1" and "Hysteresis limiting value 1", define the thresholds at which the limiting value object is set to "1" or "0" when they are exceeded or undershot.
Hysteresis limiting value 1 in W/m ²	No hysteresis 150 Watt/m ² 200 Watt/m² 250 Watt/m ²	Set the hysteresis in the range from no hysteresis to 250 W/m ² here.

Activation of limiting value 1
 LV=Limiting value,
 Hyst.=Hysteresis

**Exceed LV = ON,
 Undershoot LV - hyst. = OFF**

Exceed LV = OFF,
 Undershoot LV - hyst. = ON

Undershoot LV = ON,
 Exceed LV + hyst. = OFF

Undershoot LV = OFF,
 Exceed LV + hyst. = ON

Exceed LV = ON,
 Undershoot LV hyst. =
 No telegr.

Exceed LV = OFF,
 Undershoot LV hyst. =
 No telegr.

Undershoot LV = ON,
 Exceed LV + hyst. =
 No telegr.

Undershoot LV = OFF,
 Exceed LV + hyst. =
 No telegr.

Exceed LV = No telegr.,
 Undershoot LV hyst. = OFF

Exceed LV = No telegr.,
 Undershoot LV hyst. = ON

Undershoot LV =
 No telegr.,
 Exceed LV + hyst. = OFF

Undershoot LV =
 No telegr.,
 Exceed LV + hyst. = ON

External limiting value 1

No

16 bit value

8 bit value

Switch-on delay limiting value 1

No delay
 1s delay
 3s delay

i In conjunction with the parameters "Limiting value 1" and "Activation of limiting value 1", define the thresholds at which the limiting value object is set to "1" or "0" when they are exceeded or fallen below.

Here, it is possible to set which action is to be executed when the limiting value is crossed from an exactly defined direction.

i In conjunction with the parameters "Limiting value 1" and "Hysteresis limiting value 1", define the thresholds at which the limiting value object is set to "1" or "0" when they are exceeded or undershot.

No external limiting value 1 is parametrized

The limiting value is specified by an external device using a 2-byte value object.

The limiting value is specified by an external device using a 1-byte value object.

Only after the time set here will the current state of the limiting value be accepted in the limiting value object.

	5s delay 10s delay 15s delay 30s delay 1min delay 3min delay 5min delay 10min delay 15min delay 30min delay 60min delay	<p>This means that</p> <ul style="list-style-type: none"> - a change in the limiting value to "1" will only be sent after this time elapses, - in the case of cyclic sending of the limiting value, the changed value "1" is only sent after this time expires. <p>Therefore a "0" continues to be sent while the timer for the delay time is running.</p> <p>i If the parameter "Activation limiting value" for a condition is set to "No telegram", then the cyclic telegrams are also suppressed when the set condition is fulfilled.</p>
Switch-off delay limiting value 1	No delay 1s delay 3s delay 5s delay 10s delay 15s delay 30s delay 1min delay 3min delay 5min delay 10min delay 15min delay 30min delay 60min delay	<p>Only after the time set here will the current state of the limiting value be accepted in the limiting value object.</p> <p>This means that</p> <ul style="list-style-type: none"> - a change in the limiting value to "0" will only be sent after this time elapses, - in the case of cyclic sending of the limiting value, the changed value "0" is only sent after this time expires. <p>Therefore a "1" continues to be sent while the timer for the delay time is running.</p> <p>i If the parameter "Activation limiting value" for a condition is set to "No telegram", then the cyclic telegrams are also suppressed when the set condition is fulfilled.</p>
Sending of limiting value 1 for value change	<p>No</p> <p>Yes</p>	<p>The limiting value object is not sent following a change.</p> <p>If the parameter "Cyclic sending of the limiting value" is set to at least 1, then the limiting value object is sent cyclically regardless of any change.</p> <p>The limiting value object is sent following a change from "0" to "1" or from "1" to "0".</p> <p>i If this parameter "Sending of limiting value for value change" is set to "No" and the parameter "Cyclic sending of the limiting value" is set to "0", then the limiting value is not sent at all.</p>
Cycl. Sending of limiting value 1 (x 10 s)	0...120	<p>Set whether and at what time interval the limiting value is sent here. The set value multiplied by 10 is the repeat time in seconds. It is thus possible to set the cycle time in step widths of 10 seconds. The value "0" indicates that the limiting value object is not transmitted cyclically.</p> <p>i If this parameter "Sending of limiting value for value change" is set to "No" and the parameter "Cyclic sending of the limiting value" is set to "0", then the limiting value is not sent at all.</p>

☐ Global radiation limiting value 2 (Only visible if the parameter 'Global radiation' under 'General' is set to 'Activated' and the parameter 'Limiting values' is set here to 'Limiting values 1 and 2 activated'!)

Limiting value 2 in W/m ²	300 Watt/m ² 400 Watt/m ² 500 Watt/m ² 600 Watt/m ² 700 Watt/m ² 800 Watt/m ² 900 Watt/m² 1000 Watt/m ² 1100 Watt/m ² 1200 Watt/m ² 1300 Watt/m ²	Set the threshold for the limiting value in the range from 300 to 1300 W/m ² here. <i>i</i> In conjunction with the parameters "Limiting value 2" and "Hysteresis limiting value 2", define the thresholds at which the limiting value object is set to "1" or "0" when they are exceeded or undershot.
Hysteresis limiting value 2 in W/m ²	No hysteresis 150 Watt/m ² 200 Watt/m² 250 Watt/m ²	Set the hysteresis in the range from no hysteresis to 250 W/m ² here. <i>i</i> In conjunction with the parameters "Limiting value 2" and "Activation of limiting value 2", define the thresholds at which the limiting value object is set to "1" or "0" when they are exceeded or fallen below.
Activation of limiting value 2 LV=Limiting value, Hyst.=Hysteresis	Exceed LV = ON, Undershoot LV - hyst. = OFF Exceed LV = OFF, Undershoot LV - hyst. = ON Undershoot LV = ON, Exceed LV + hyst. = OFF Undershoot LV = OFF, Exceed LV + hyst. = ON Exceed LV = ON, Undershoot LV hyst. = No teleg. Exceed LV = OFF, Undershoot LV hyst. = No teleg. Undershoot LV = ON, Exceed LV + hyst. = No teleg. Undershoot LV = OFF, Exceed LV + hyst. = No teleg. Exceed LV = No teleg., Undershoot LV hyst. = OFF Exceed LV = No teleg., Undershoot LV hyst. = ON	Here, it is possible to set which action is to be executed when the limiting value is crossed from an exactly defined direction. <i>i</i> In conjunction with the parameters "Limiting value 2" and "Hysteresis limiting value 2", define the thresholds at which the limiting value object is set to "1" or "0" when they are exceeded or undershot.

	Undershoot LV = No teleg., Exceed LV + hyst. = OFF	
	Undershoot LV = No teleg., Exceed LV + hyst. = ON	
External limiting value 2	No	No external limiting value 2 is parametrized
	16 bit value	The limiting value is specified by an external device using a 2-byte value object.
	8 bit value	The limiting value is specified by an external device using a 1-byte value object.
Switch-on delay limiting value 2	No delay 1s delay 3s delay 5s delay 10s delay 15s delay 30s delay 1min delay 3min delay 5min delay 10min delay 15min delay 30min delay 60min delay	Only after the time set here will the current state of the limiting value be accepted in the limiting value object. This means that - a change in the limiting value to "1" will only be sent after this time elapses, - in the case of cyclic sending of the limiting value, the changed value "1" is only sent after this time expires. Therefore a "0" continues to be sent while the timer for the delay time is running. i If the parameter "Activation limiting value" for a condition is set to "No telegram", then the cyclic telegrams are also suppressed when the set condition is fulfilled.
Switch-off delay limiting value 2	No delay 1s delay 3s delay 5s delay 10s delay 15s delay 30s delay 1min delay 3min delay 5min delay 10min delay 15min delay 30min delay 60min delay	Only after the time set here will the current state of the limiting value be accepted in the limiting value object. This means that - a change in the limiting value to "0" will only be sent after this time elapses, - in the case of cyclic sending of the limiting value, the changed value "0" is only sent after this time expires. Therefore a "1" continues to be sent while the timer for the delay time is running. i If the parameter "Activation limiting value" for a condition is set to "No telegram", then the cyclic telegrams are also suppressed when the set condition is fulfilled.
Sending of limiting value 2 for value change	No	The limiting value object is not sent following a change. If the parameter "Cyclic sending of the limiting value" is set to at least 1, then the limiting value object is sent cyclically regardless of any change.
	Yes	The limiting value object is sent following a change from "0" to "1" or from "1" to "0".

Cycl. Sending of limiting value 2
(x 10 s) 0...120

- i** If this parameter "Sending of limiting value for value change" is set to "No" and the parameter "Cyclic sending of the limiting value" is set to "0", then the limiting value is not sent at all.

Set whether and at what time interval the limiting value is sent here. The set value multiplied by 10 is the repeat time in seconds. It is thus possible to set the cycle time in step widths of 10 seconds. The value "0" indicates that the limiting value object is not transmitted cyclically.

- i** If this parameter "Sending of limiting value for value change" is set to "No" and the parameter "Cyclic sending of the limiting value" is set to "0", then the limiting value is not sent at all.

4.2.4.18 Parameter group "GPS/Glonass"

Description	Values	Comment
<input type="checkbox"/> GPS/Glonass (Only visible if the parameter 'GPS/GLONASS' under 'General' is set to 'Activated!') (Measuring range 0...100 %)		
Cycl. sending of the measured value (x 10 s)	0...120	Set here whether and at what time interval the value is sent. The set value multiplied by 10 is the repeat time in seconds. It is thus possible to set the cycle time in step widths of 10 seconds. The value "0" means that no values received via GPS/Glonass are sent. i The cyclic telegrams sent via this setting are independent of the telegrams resulting from the setting "Send measured value on... measured value difference".
Cyclical sending of the sun position	0...255	The device sends the sun position to the KNX repeatedly via the "GPS.Elevation" and "GPS.Azimuth" communication objects if a value greater than 0 is set here. The value set here, multiplied by 10, defines the cycle time in seconds after which the sun position is sent to the KNX. If the setting is "0", the sun position is not transmitted cyclically.
Send sun position at	1° elevation change 3° elevation change 5° elevation change 10° elevation change 15° elevation change	The device sends the sun position to the KNX via the "GPS.Elevation" and "GPS.Azimuth" communication objects if the elevation angle has changed by the value entered here. The entry selected here specifies the value by which the elevation angle must at least change for the sun position to be resent to the KNX.

4.2.4.19 Parameter group "Monitoring"

Description	Values	Comment
<input type="checkbox"/> Monitoring (Only visible if the parameter 'Monitoring' under 'General' is set to 'Activated'!)		
Cyclical sending of the monitoring bits (x 10 s)	0...120	<p>Set here whether and at what time interval the monitoring bits are sent cyclically. The set value multiplied by 10 is the repeat time in seconds. It is thus possible to set the cycle time in step widths of 10 seconds.</p> <p>The value "0" means that no cyclic sending is carried out.</p> <p>i The cyclic telegrams sent via this setting are independent of the fact that the specific telegrams of the individual monitoring bits are sent in any case with each change.</p>
Monitor power supply	<p>24 V o.k. = 0, 24V not o.k. = 1</p> <p>24 V o.k. = 1, 24V not o.k. = 0</p>	<p>Set here the polarity of the monitoring bit.</p> <p>i In order to obtain reliable measurement results, it is necessary for the proper 24 V AC/DC voltage to be present. If you use the weather station to protect costly outdoor equipment against the adverse effects of weather, then it is essential to monitor this voltage. If there is no voltage, then the outdoor equipment should be moved to a protected state as quickly as possible.</p>
Monitoring wind signal	<p>monitor do not monitor</p>	<p>Here, set the parameter to "Monitor" if a check to see if the wind transmitter is supplying appropriate values is to take place.</p> <p>i If you use the weather station to protect costly outdoor equipment against the effects of wind, then you should check the supplied data for plausibility. Use the data to be entered for the parameters "Max. time for 'No wind' in hours" and "Max. time for 'Wind unchanged' in minutes. If the values do not appear to be reasonable, then for the sake of safety the outdoor equipment should be moved to a protected state as quickly as possible.</p>
Max. time for "No wind" in hours	1...10...180	<p>If the time set here is exceeded, it is assumed that the wind signal is faulty, for example due to an electronic defect.</p> <p>i For reasonable values, please consult the meteorological station responsible for the location.</p>

Max. time for "Wind speed unchanged" in minutes 1...**10**...255

i This parameter is only visible if the parameter "Monitor wind signal" is set to "Monitor".

If there is a constant wind signal for longer than the time set here, a defect is assumed.

i For a reasonable value, please consult the meteorological station responsible for the location.

i This parameter is only visible if the parameter "Monitor wind signal" is set to "Monitor".

Max. time for "Wind direction unchanged" in minutes 1...**10**...255

If there is a constant wind signal for longer than the time set here, a defect is assumed.

i For a reasonable value, please consult the meteorological station responsible for the location.

i This parameter is only visible if the parameter "Monitor wind signal" is set to "Monitor".

5 Appendix

5.1 Index

Icons		
'AND'	63	
A		
Absolute humidity.....	80	GPS.Azimuth.....
air pressure.....	85	GPS.Elevation.....
Allen screw.....	7	GPS.Geographic latitude.....
AND with return.....	63	GPS.Geographic longitude.....
anti-icing protection.....	55	GPS.location height.....
Application version.....	19	GPS.Time change.....
awning protection.....	64	GPS/Glonass parameter.....
		185
B		H
Beaufort.....	58-59	Hysteresis of the limiting values.....
bft	58-59	89
Blind/shutter height control.....	70	L
Brightness detection.....	74	Limiting value 1.....
Brightness sensor.....	74	Limiting value 2.....
Building orientation.....	68	Limiting value settings.....
		limiting value specification.....
C		limiting values.....
Calculation of the sun position.....	67	Location height.....
CEP (50%).....	87	Logic gate.....
Comfort.....	83	logic gate configuration.....
compass direction.....	14	Logic gate parameter.....
Configuration.....	19	Logic gate parameter.....
		106-107
D		106-107
Device components.....	7	M
Dimensions.....	7	main area of application.....
Disabling module parameter.....	104	Measured value absolute humidity.....
		Measured value felt temperature.....
E		Measured value for brightness.....
ETS search paths:.....	19	Measured value for brightness and.....
'exclusive OR'.....	63	twilight
External limiting value 1.....	47	Measured value for temperature.....
External limiting value 2.....	51	Measured value for twilight.....
		Measured value wind speed.....
F		Measured value, absolute humidity.....
Felt temperature.....	81	Measured value, air pressure.....
		Measured value, comfort.....
G		Measured value, global radiation.....
global radiation.....	86	Measured value, oppressiveness.....
Glonass.....	87	Measured value, relative humidity.....
GPS	87	Measured value, wind direction.....
GPS. Date.....	21	measured values.....
GPS. Time.....	21	mounting location.....
		8
		O
		Opening angle to the sun.....
		Oppressiveness.....
		83

'OR'63
 Orienting the weather station..... 13

P

Parameter abs. Air humidity..... 146
 Parameter Air pressure.....173
 Parameter Brightness..... 116
 Parameter Comfort..... 172
 Parameter Felt temperature.....165
 Parameter Global radiation..... 179
 Parameter monitoring..... 186
 Parameter Precipitation..... 143
 Parameter rel. Air humidity..... 152
 Parameter Shading control..... 109
 Parameter Temperature sensor..... 158
 Parameter Twilight.....123
 Parameter Wind direction..... 136
 Parameter Wind speed..... 130
 PEI type..... 19
 Physical sensors.....73
 Plausibility check..... 57
 Precipitation sensor..... 79
 Protection outdoor equipment..... 54

R

Real Time Clock..... 87
 Relative humidity..... 80
 Response of the limiting value 91
 object

S

Sending the measured values..... 88
 shading control..... 66
 Shading disabling..... 71
 Switch-on and switch-off delay of 94
 the limiting values

T

teaching function.....89,93
 Temperature sensor..... 81
 Twilight.....75

V

Venetian blind control..... 69

W

Wind area signal.....76-77
 wind direction..... 76
 wind speed.....76
 wind speed levels..... 58-59

Somfy Activités SA
70 Avenue du Nouveau Monde
74300 Cluses
France

www.somfy.com
www.somfy.com/projects

© 2021
SOMFY ACTIVITES SA
Société Anonyme
Capital 35.000 000 €
RCS Annecy 303.970.230